

# Churn Possibilities and Impossibilities

Dianne Foreback, Mikhail Nesterenko,  
**Sébastien Tixeuil**

**NETYS, Essaouira, May 10, 2018**



# Context & Motivation

# Distributed Systems

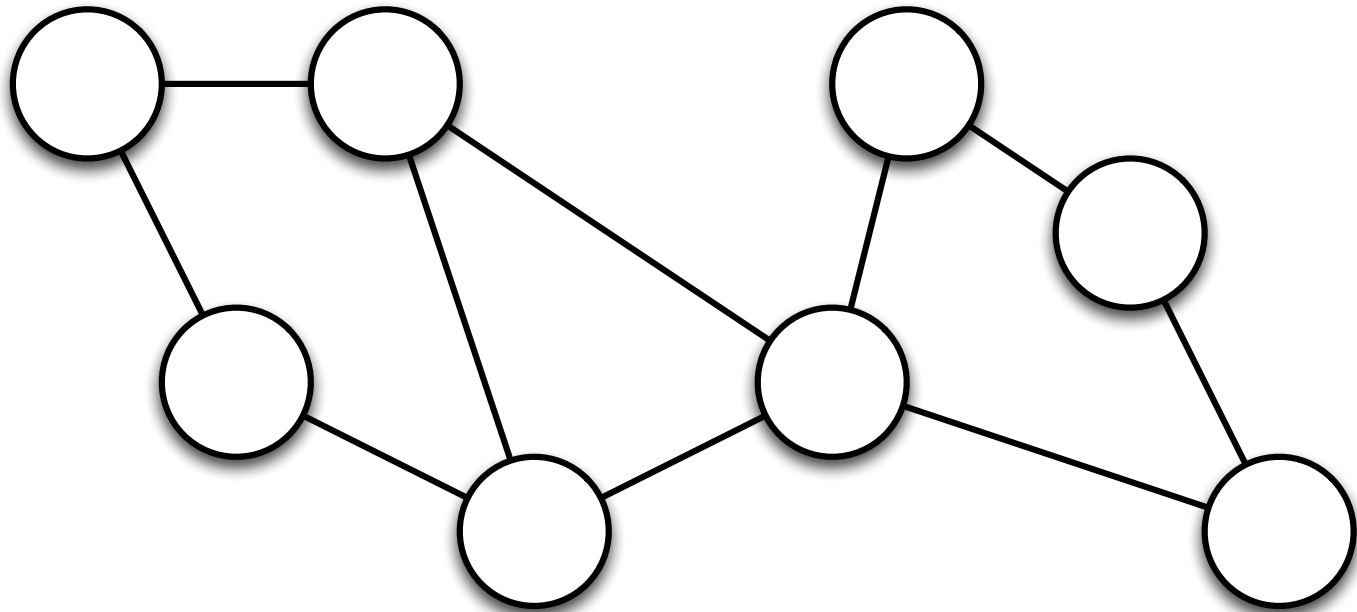

# Overlay Networks

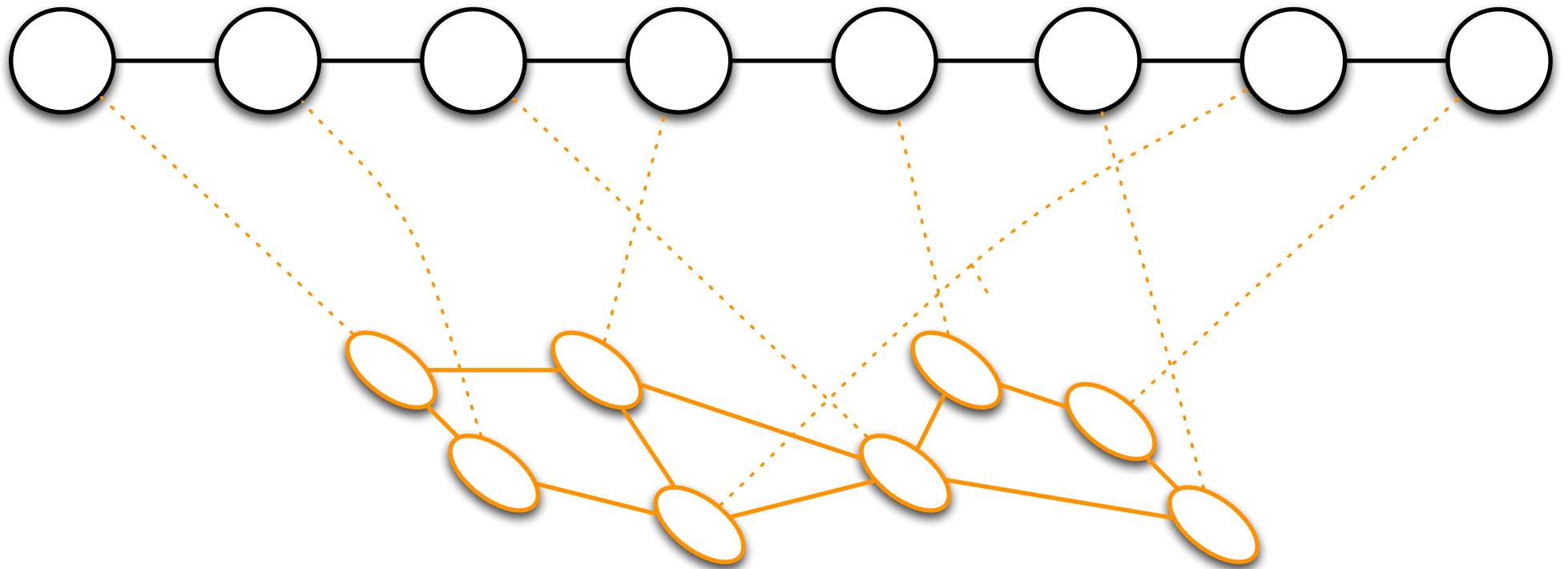

# Overlay Networks

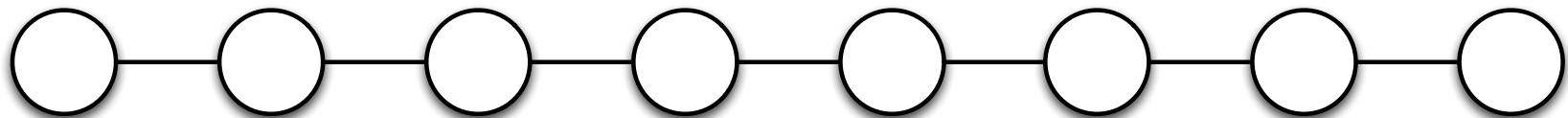
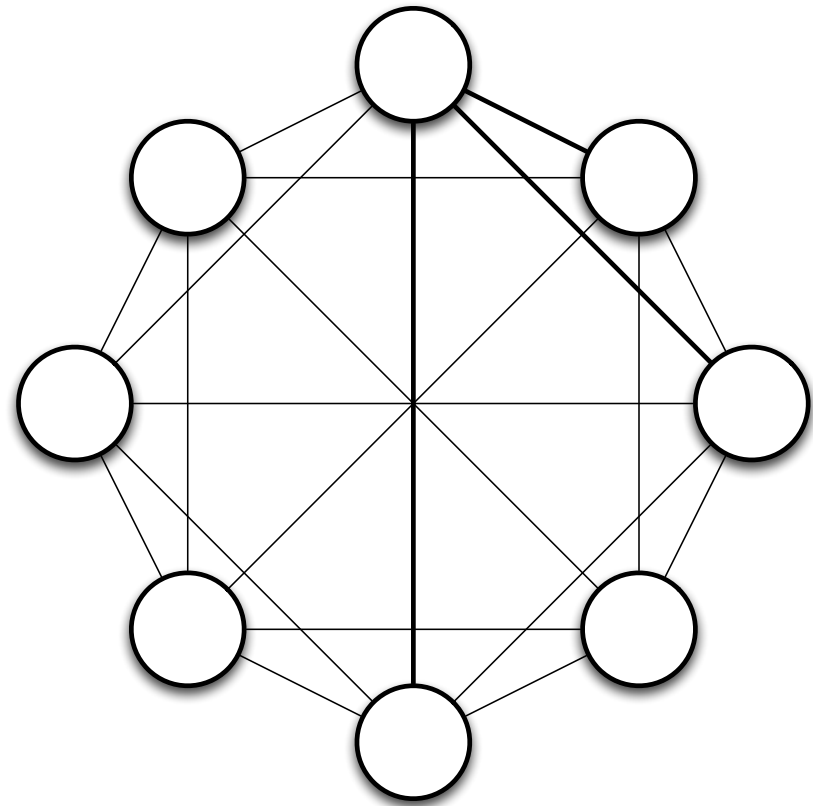
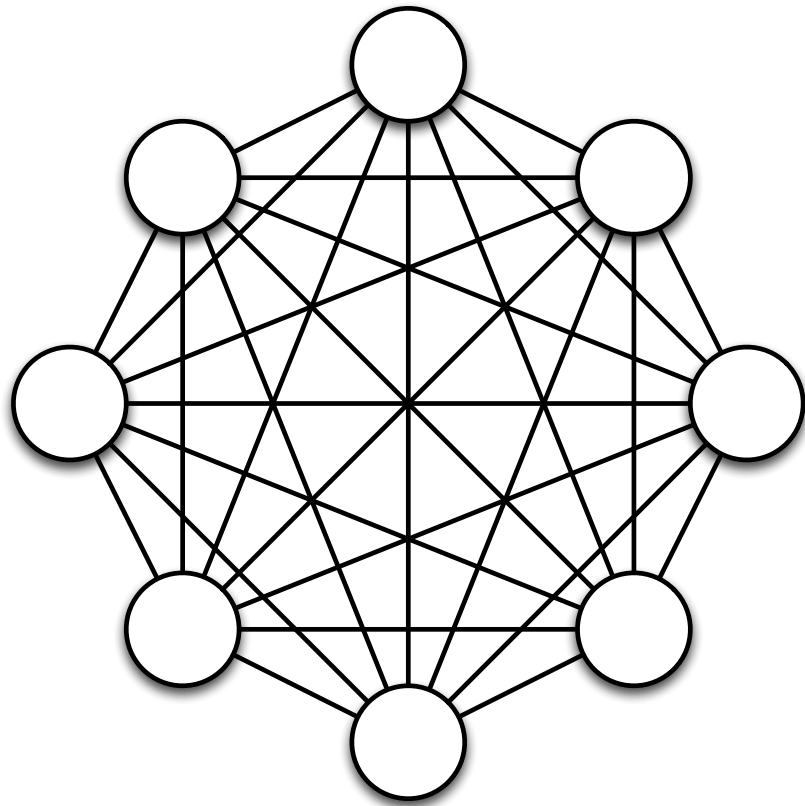

# Churn

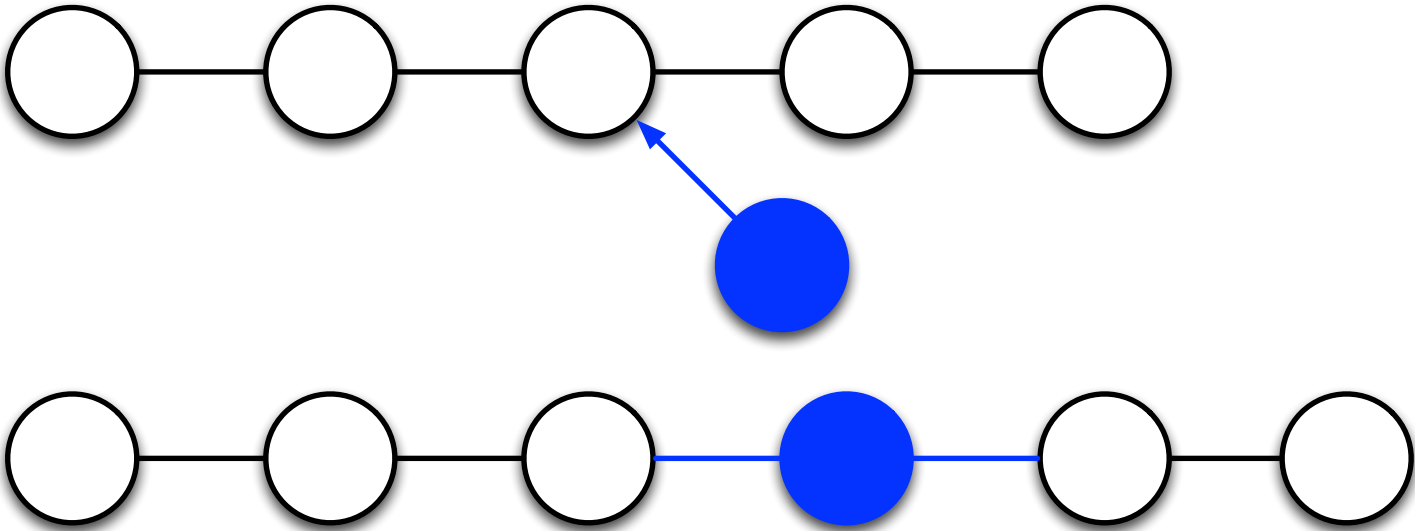

# Churn

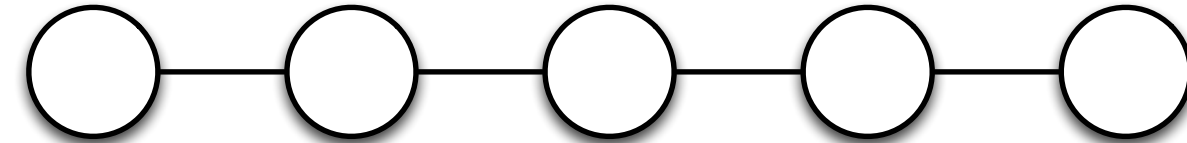
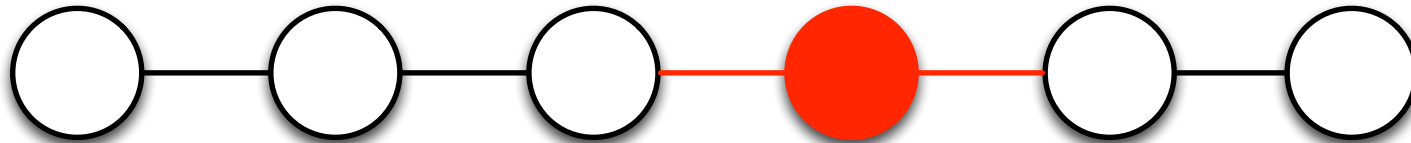
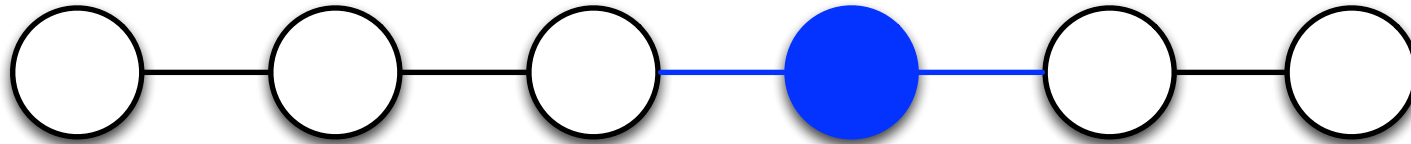
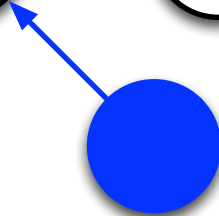
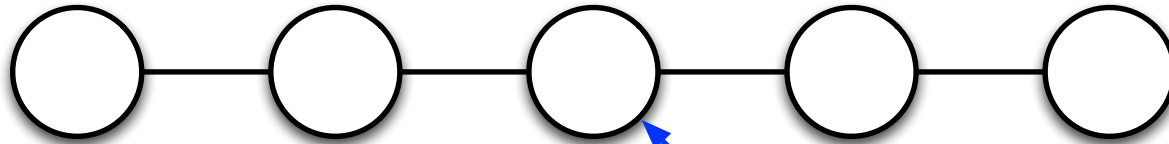

# Churn





# Limited Churn

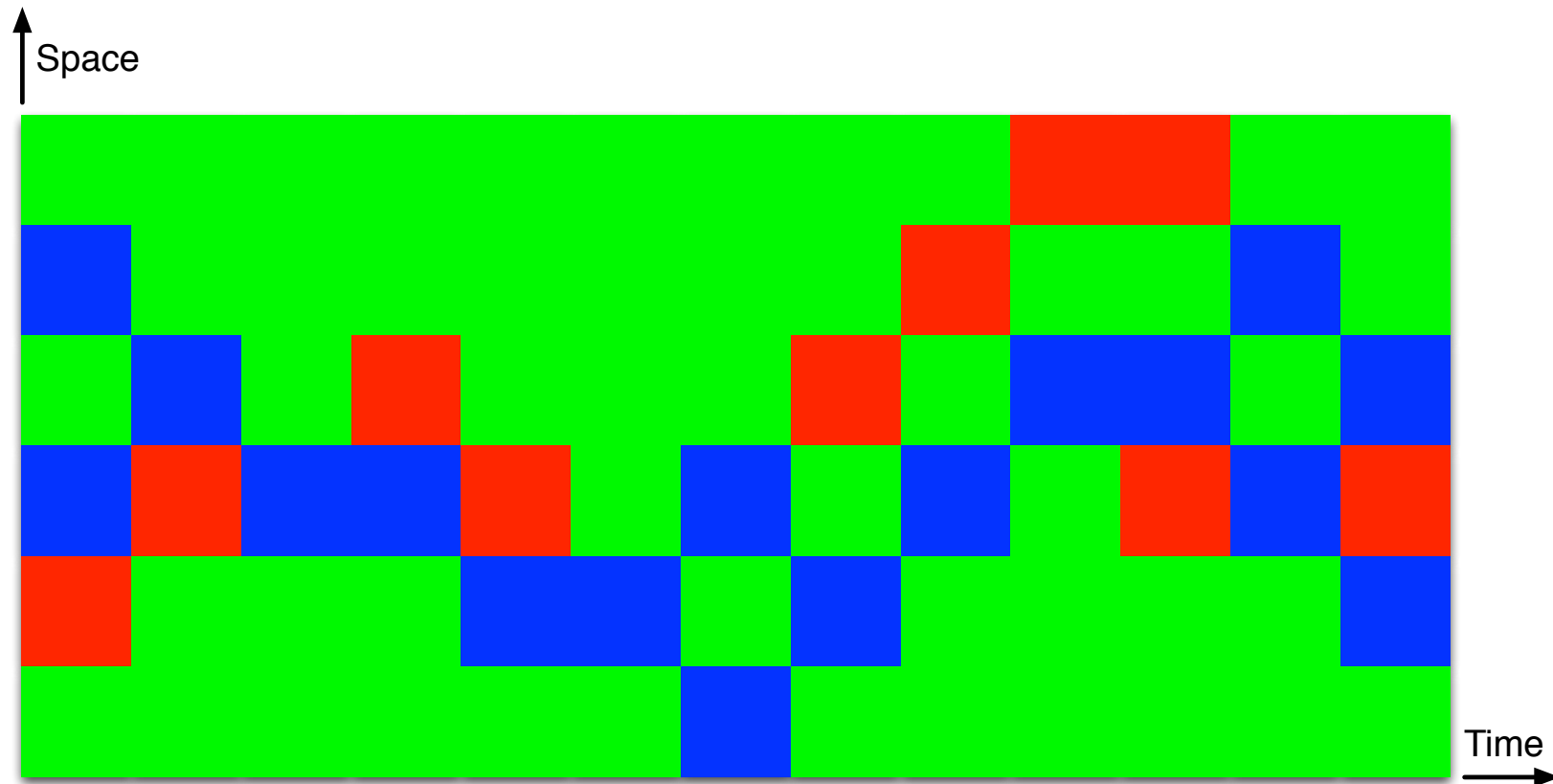

# Finite Churn

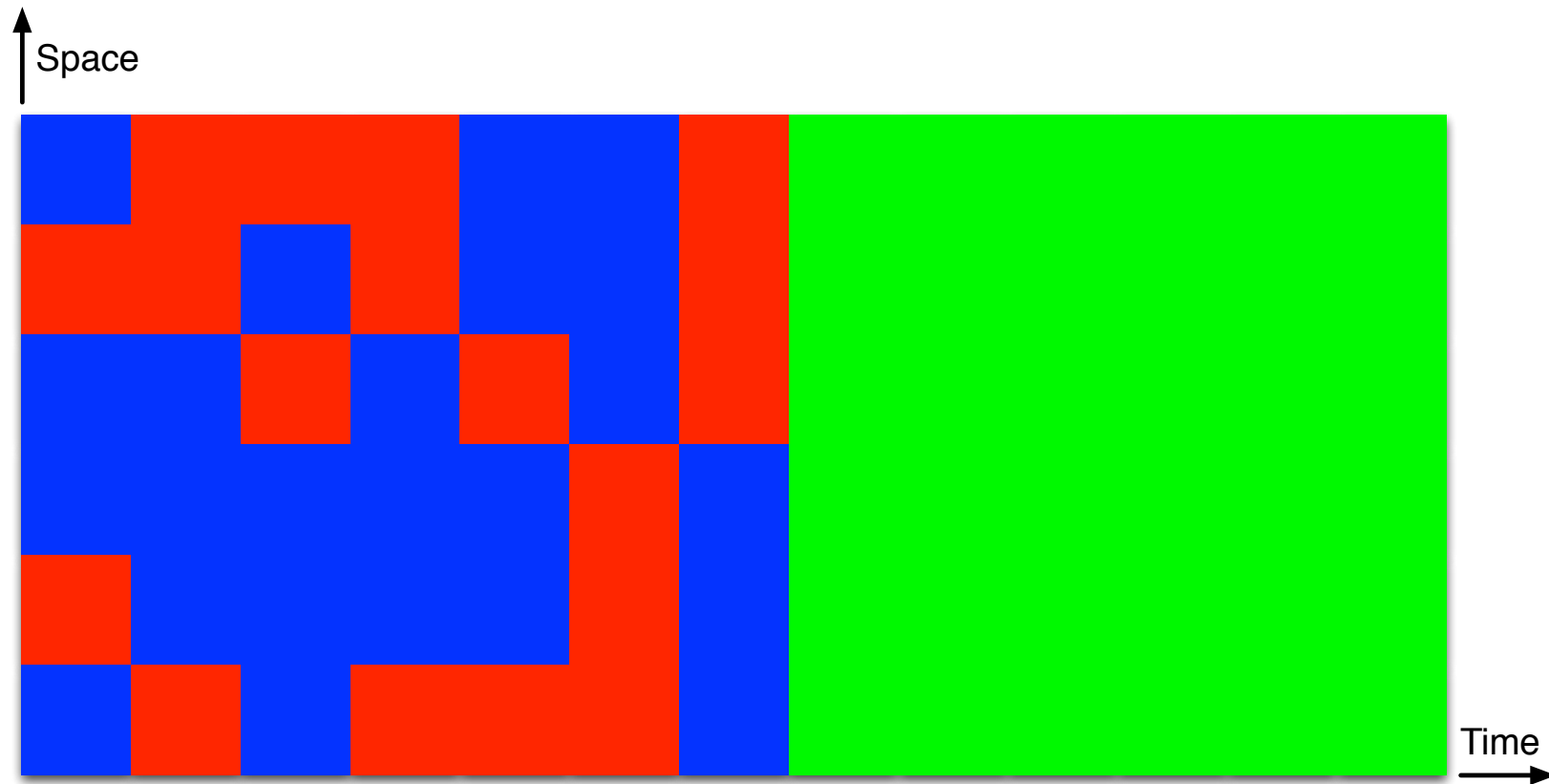

# Unlimited and Infinite Churn

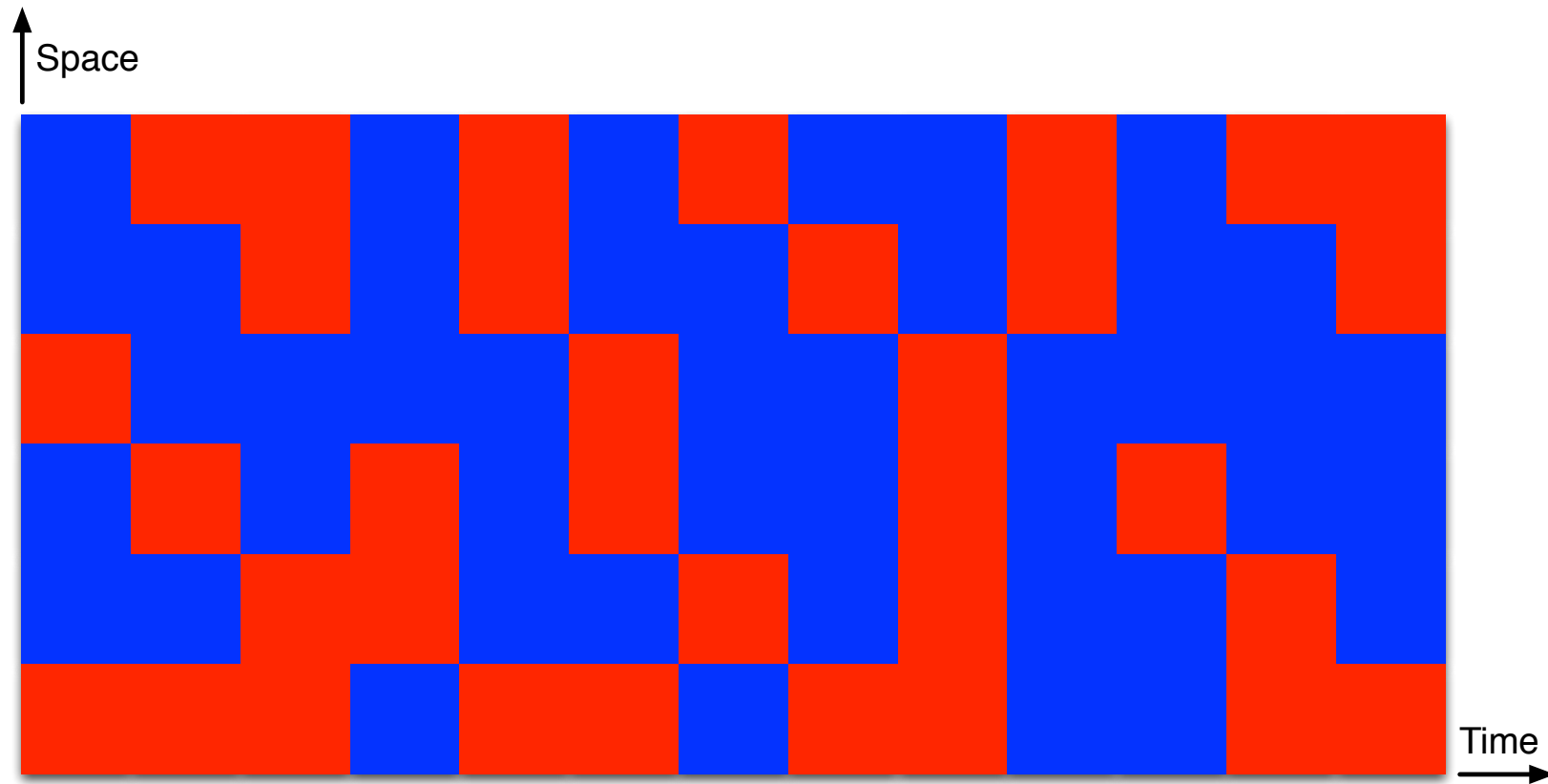

# **Adversarial vs. Cooperative Churn**

# Unlimited Adversarial Churn

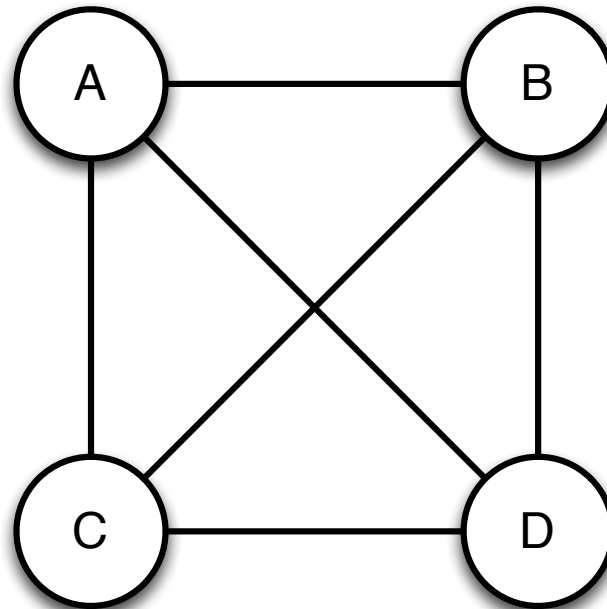

# Unlimited Adversarial Churn

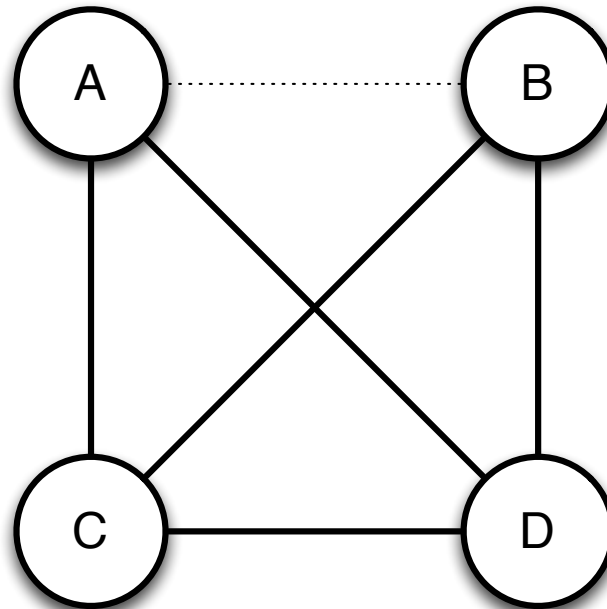

# Unlimited Adversarial Churn

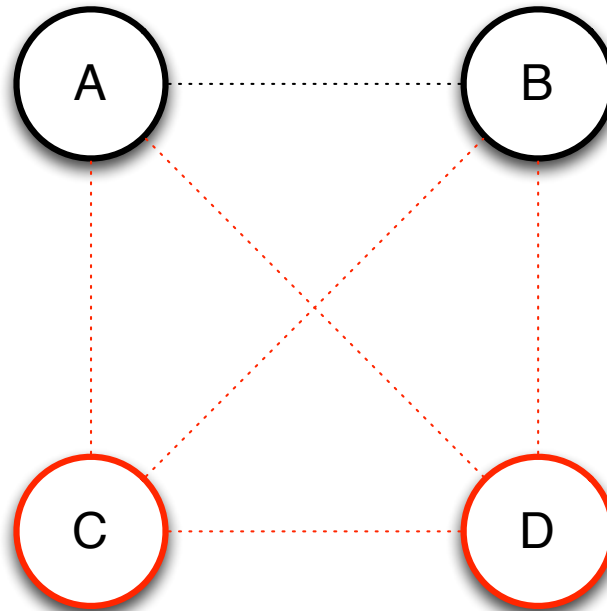

# Unlimited Adversarial Churn

	Unlimited
Adversarial	Impossible
Cooperative	?



# **Global *vs.* Local Protocols**

# Infinite Unlimited Global Protocol

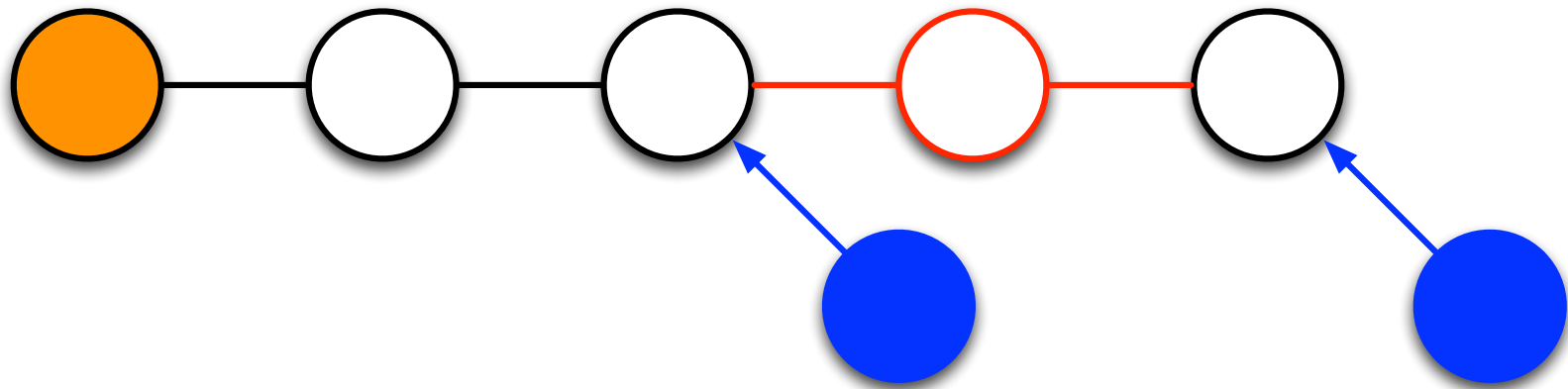

# Infinite Unlimited Global Protocol

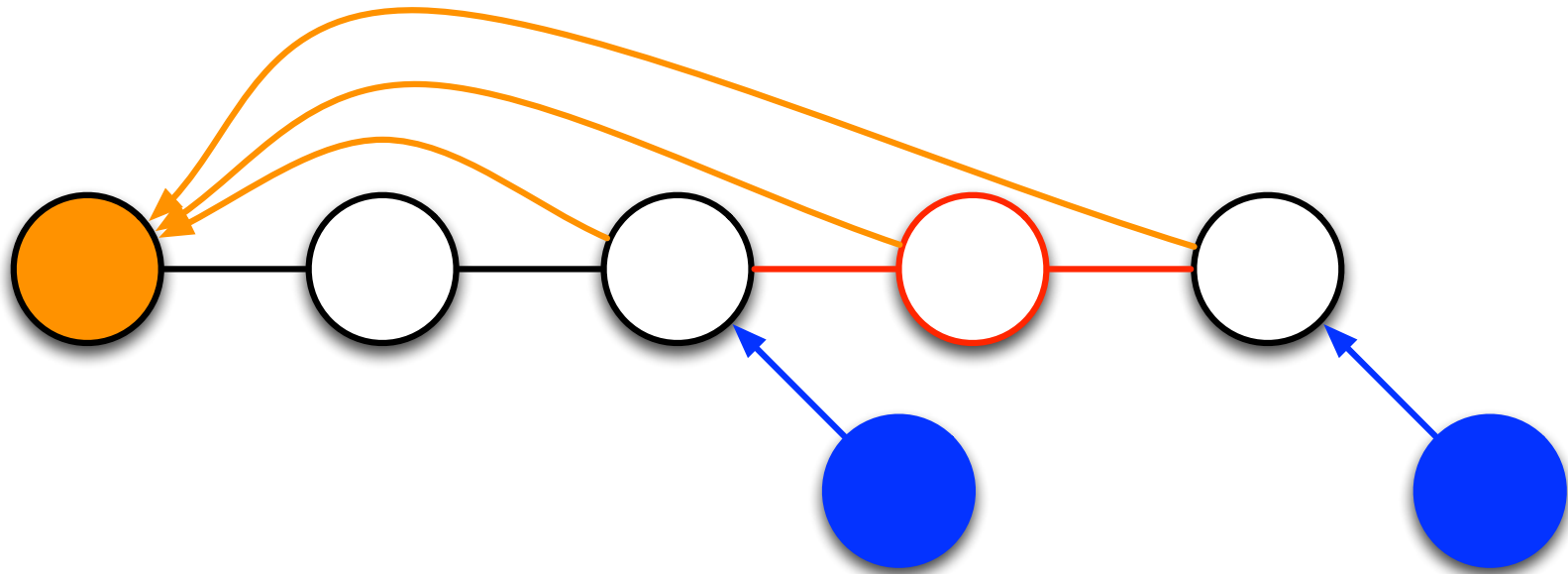

# Infinite Unlimited Global Protocol

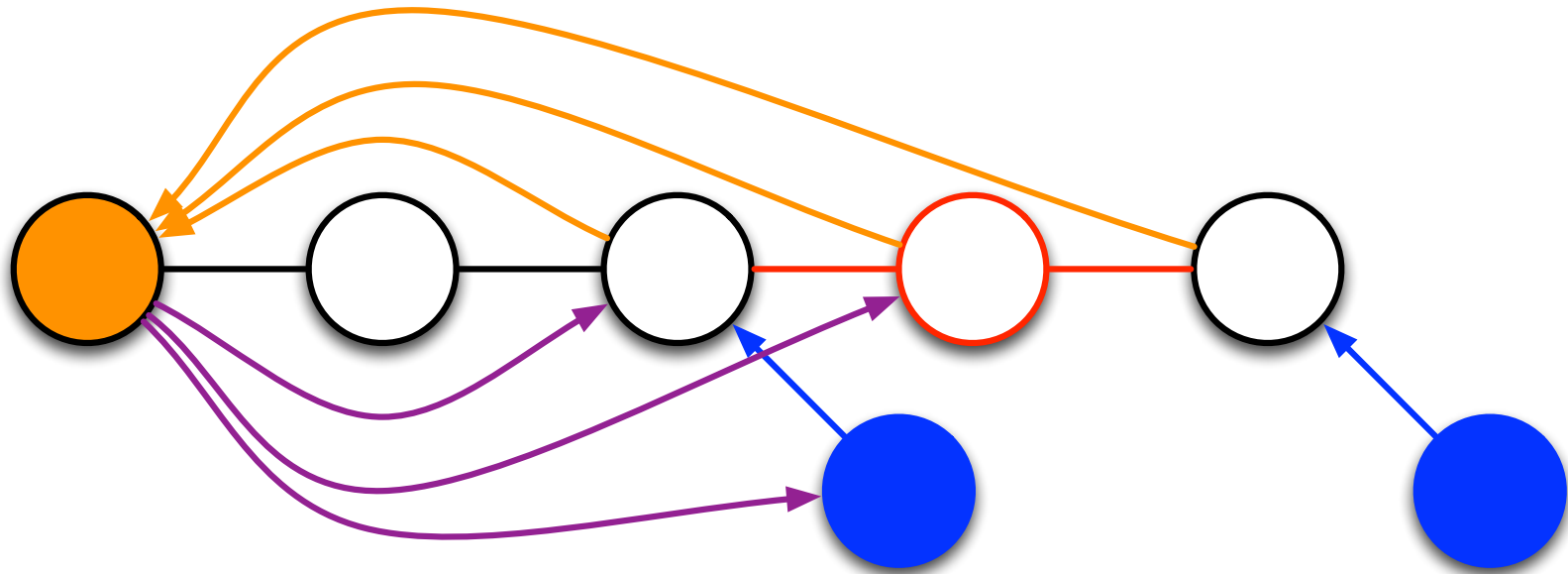

# Infinite Unlimited Global Protocol

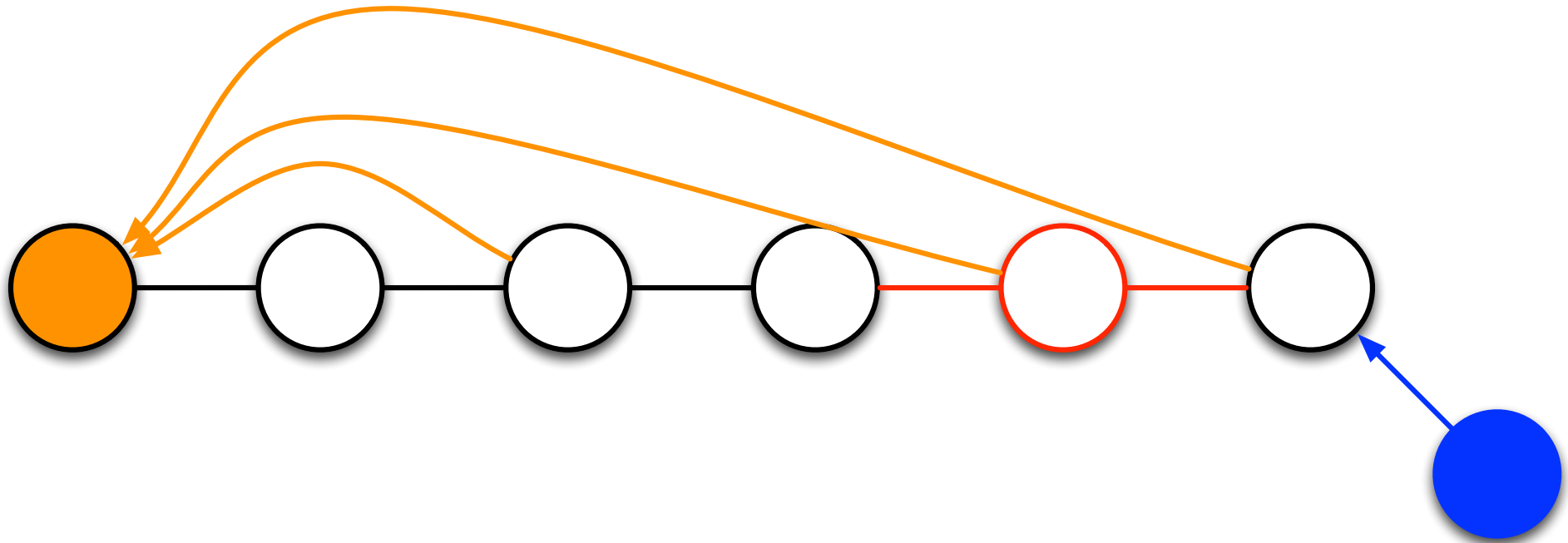

# Infinite Unlimited Global Protocol

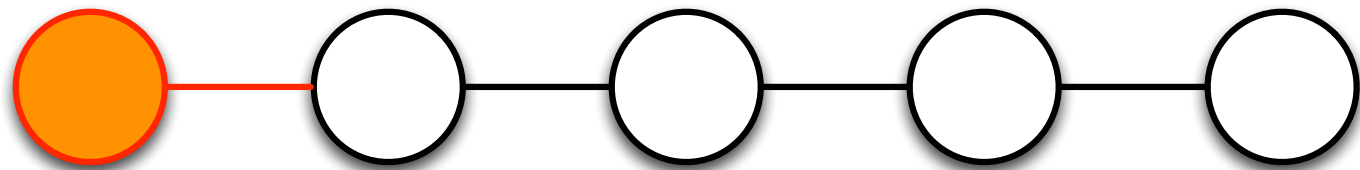

# Infinite Unlimited Global Protocol

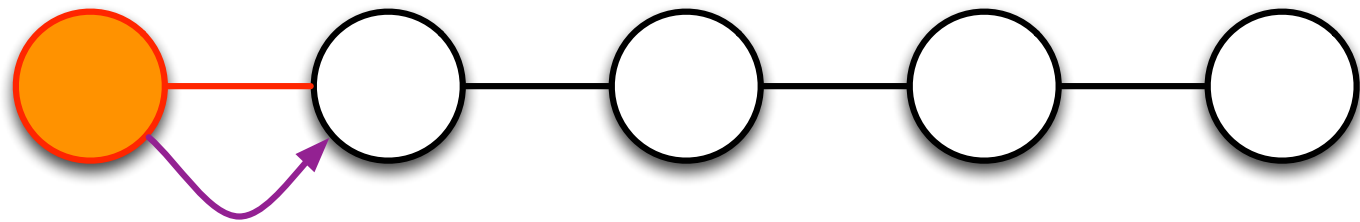

# Infinite Unlimited Global Protocol

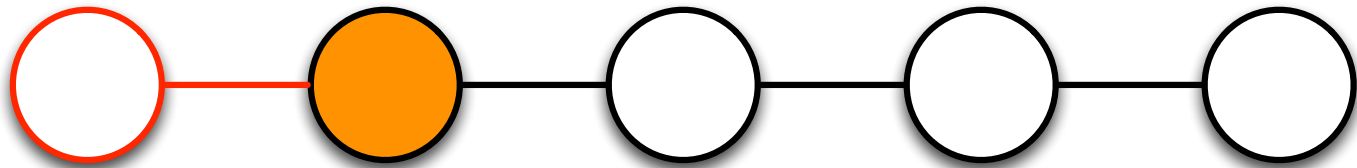



# Infinite Unlimited Global Protocol

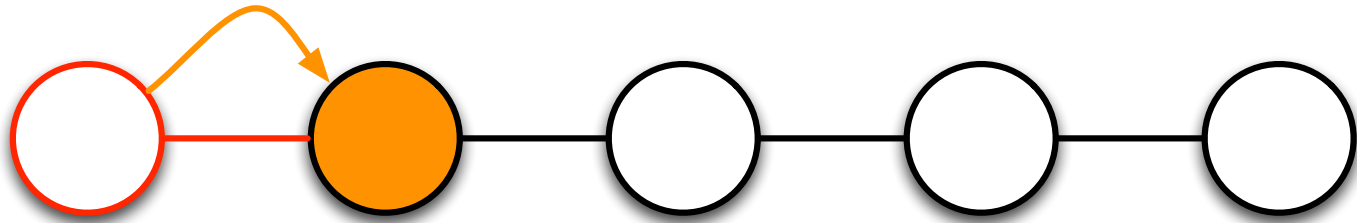

# Global Solution

		Infinite and Unlimited
Adversarial		Impossible
Cooperative	Global	Possible
	Local	?

# Local Protocols

# Local Protocol

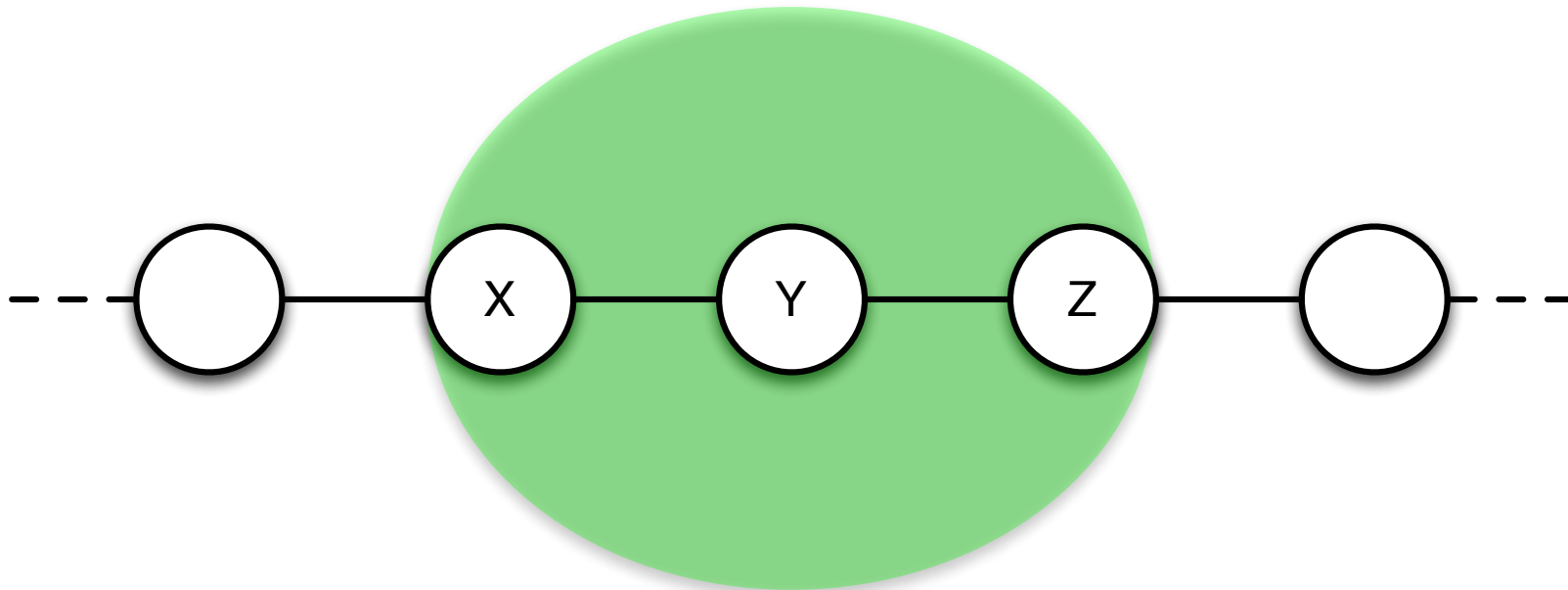

# Local Protocol

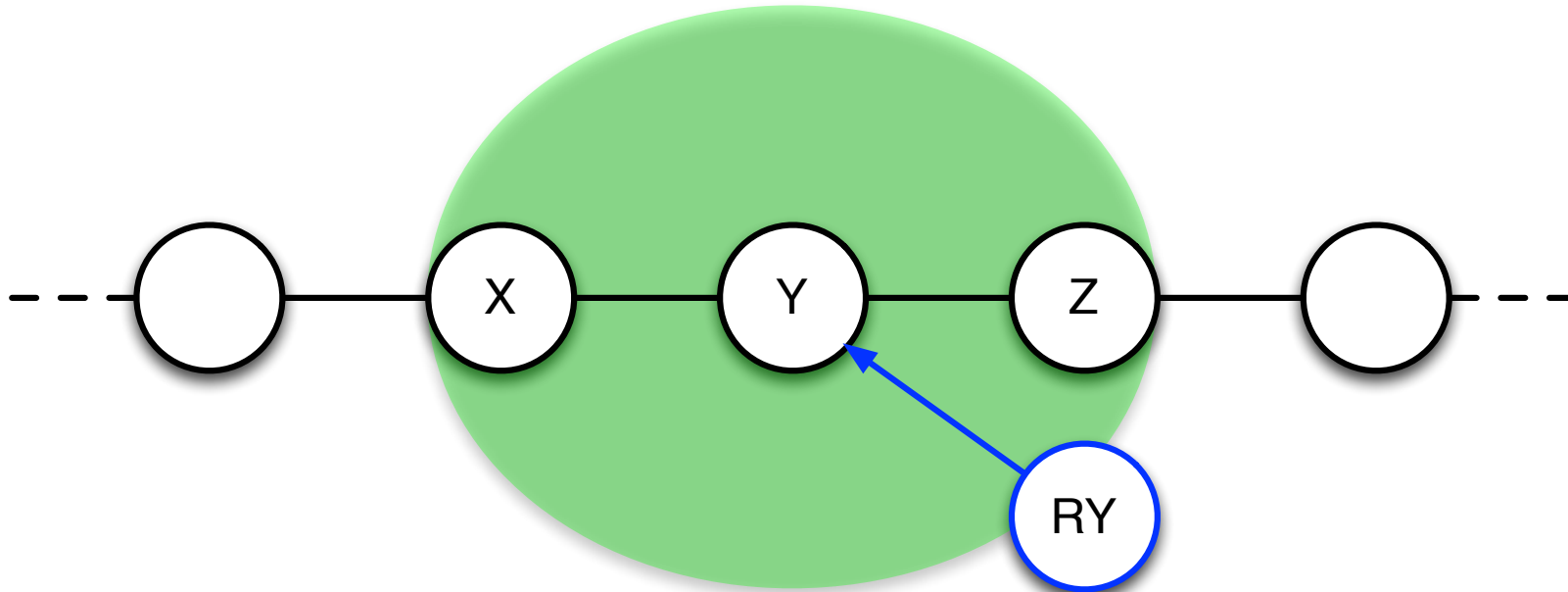

# Local Protocol Join

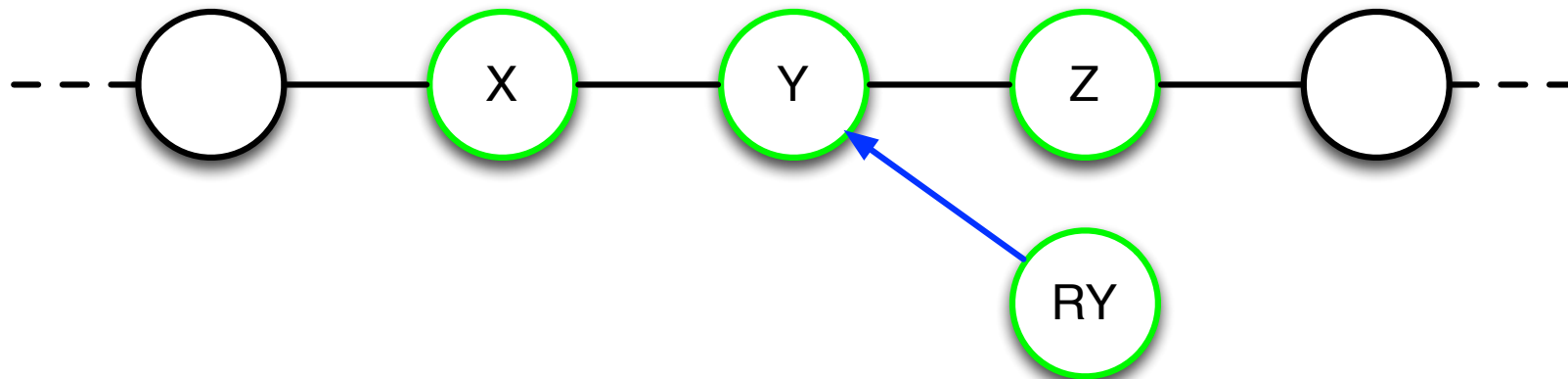

# Local Protocol Join

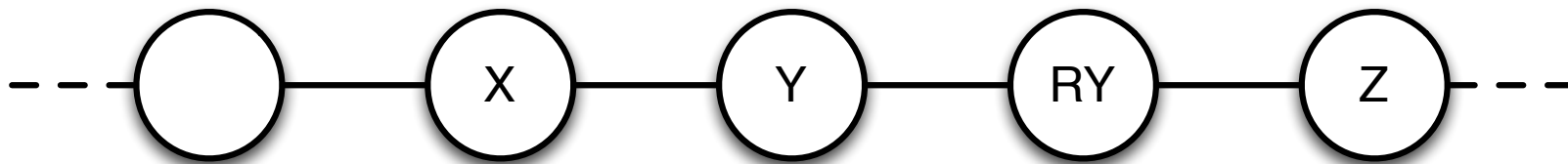

# Local Protocol Leave

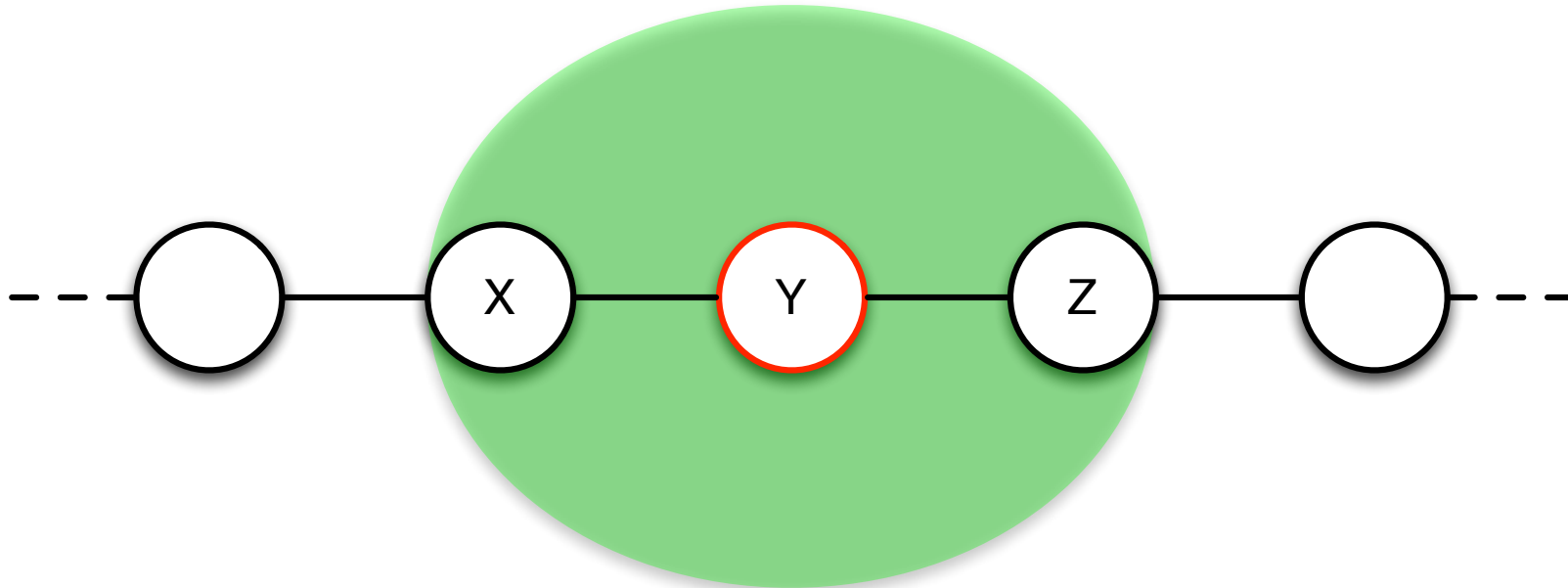



# Local Protocol Leave

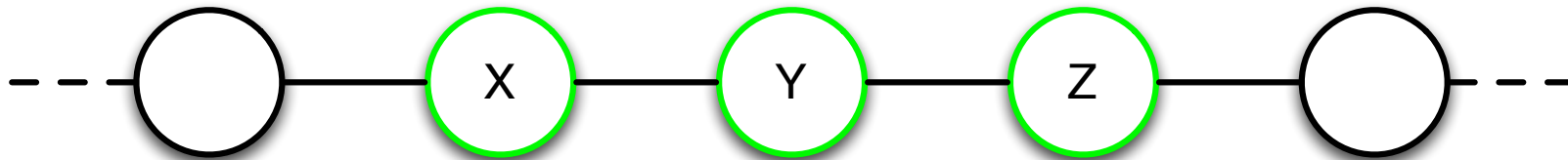

# Local Protocol Leave

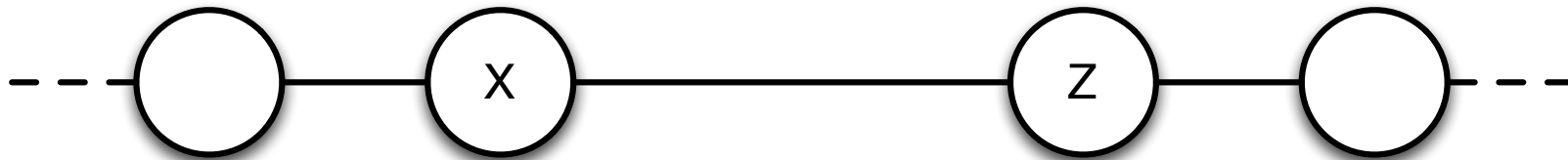

# Expansive Overlays

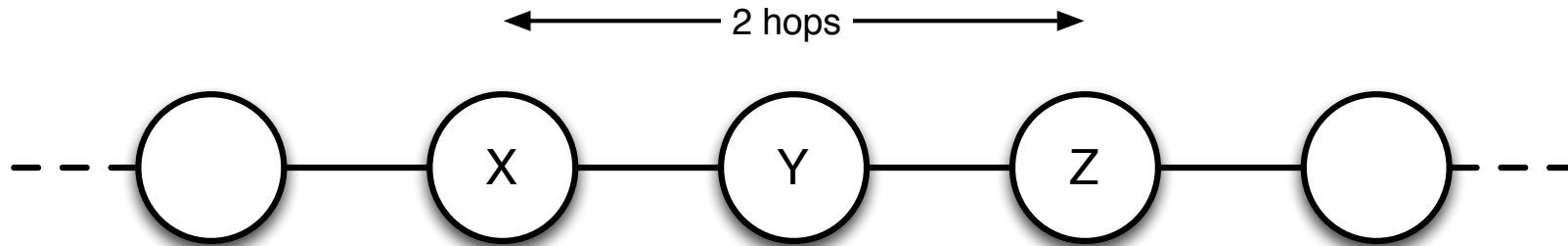

# Expansive Overlays

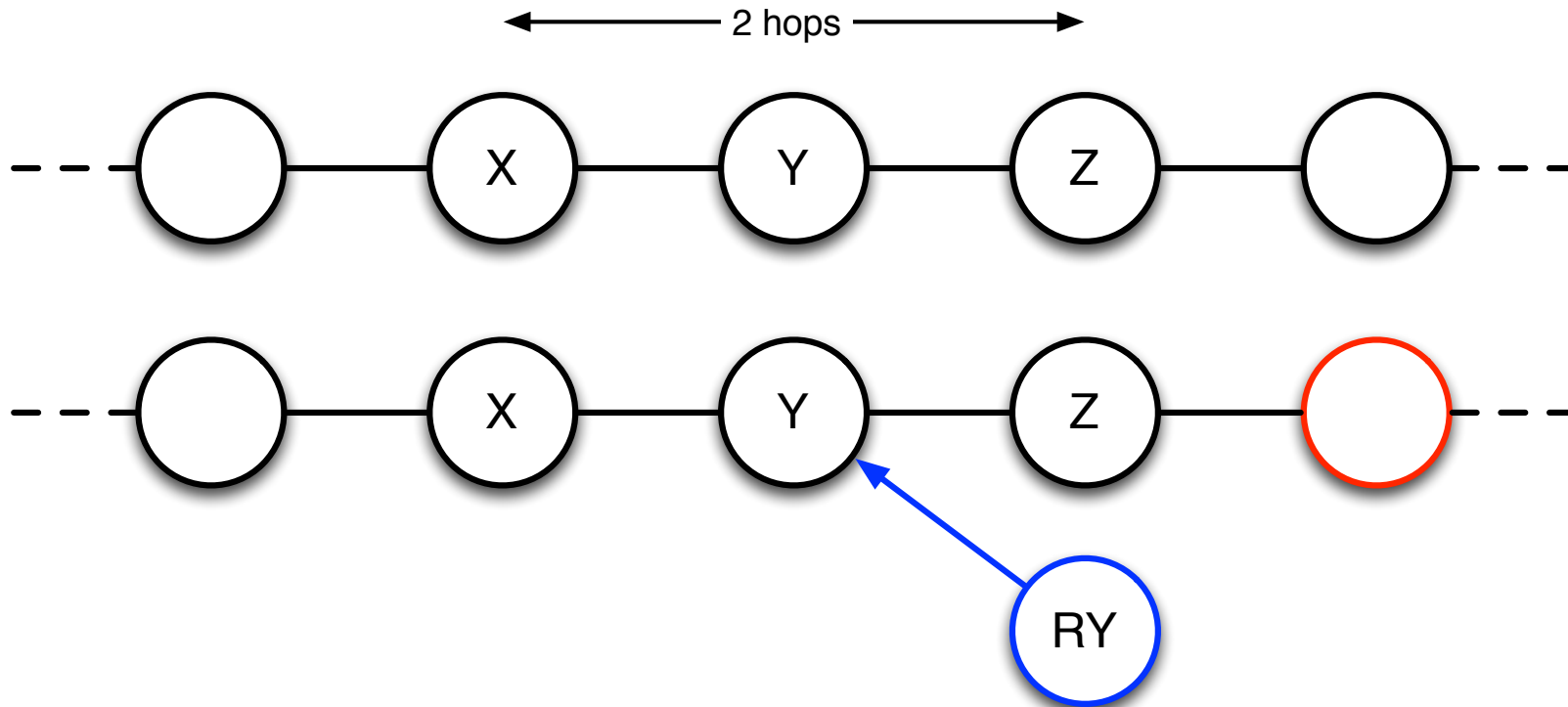

# Expansive Overlays

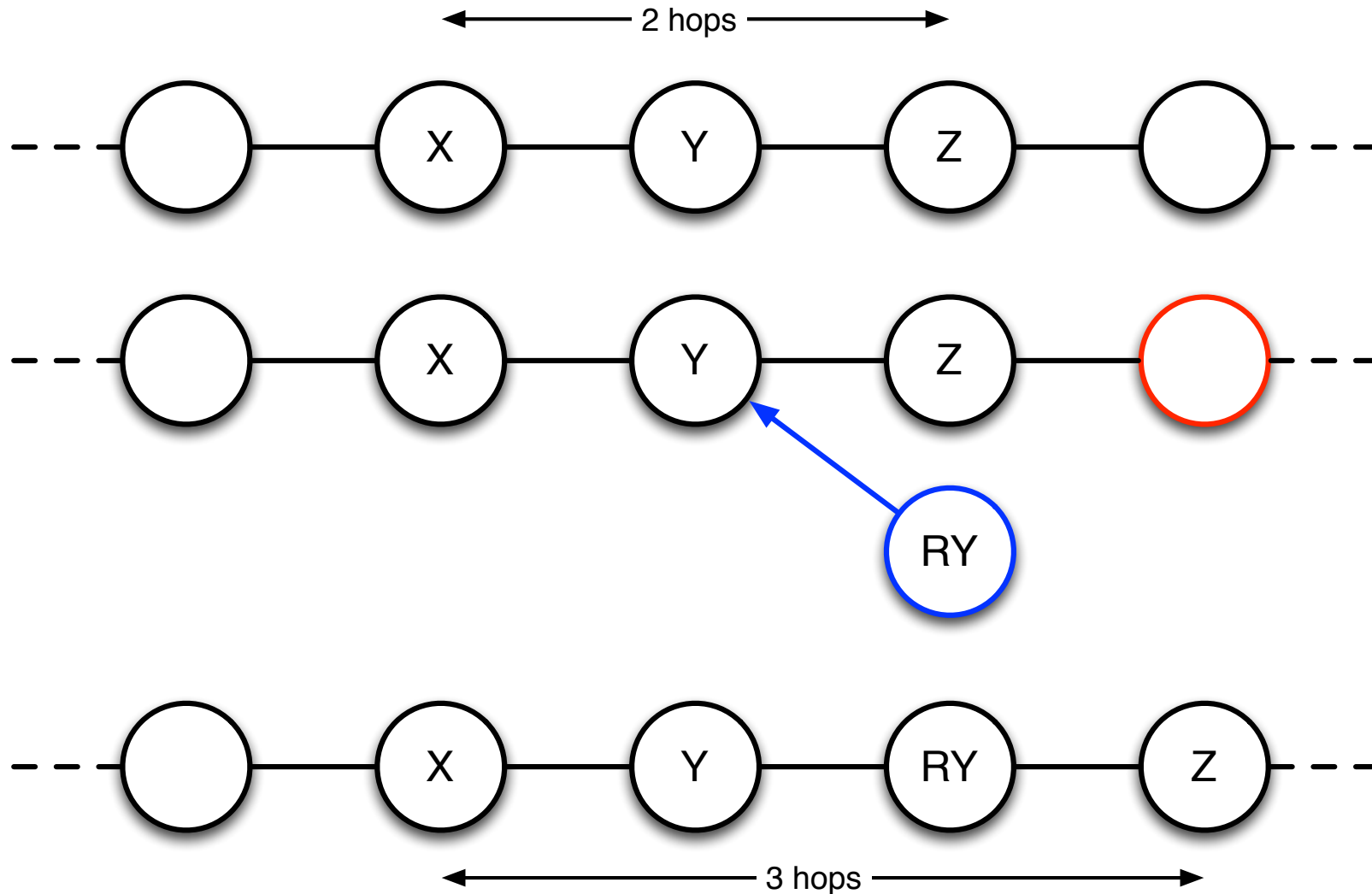

# Expansive Overlays

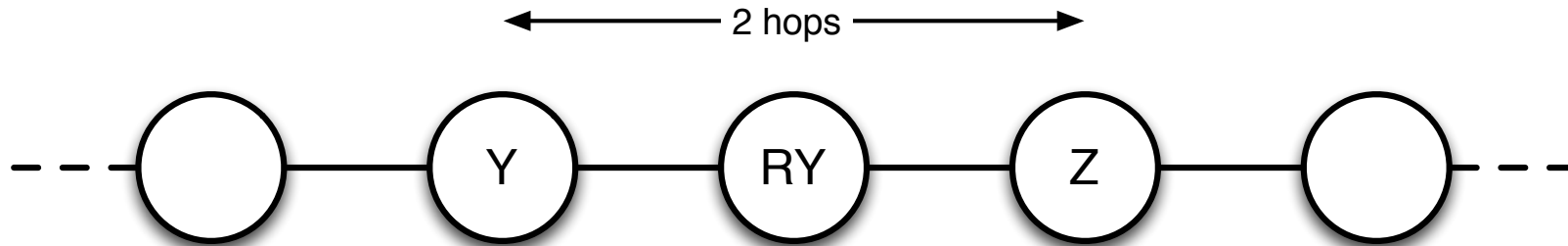

# Expansive Overlays

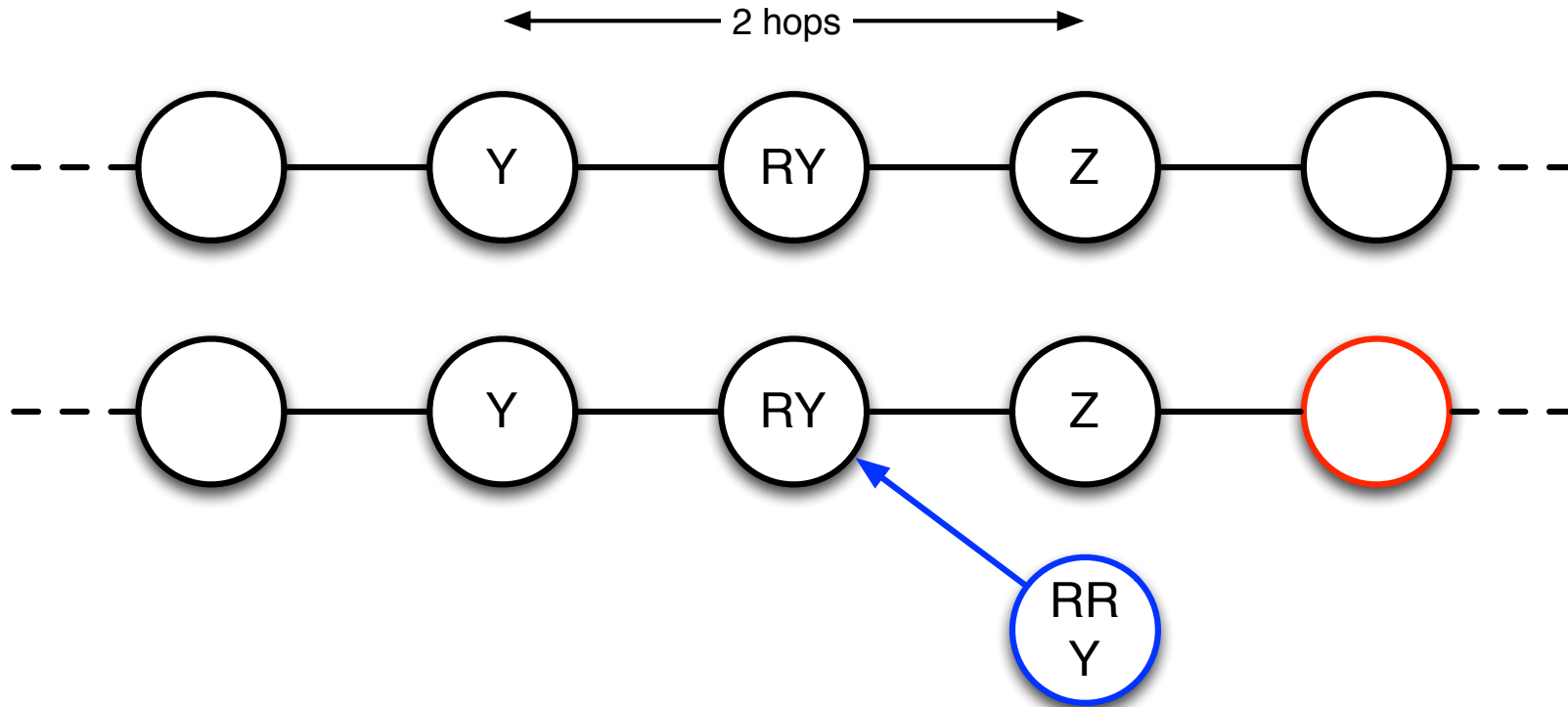

# Expansive Overlays

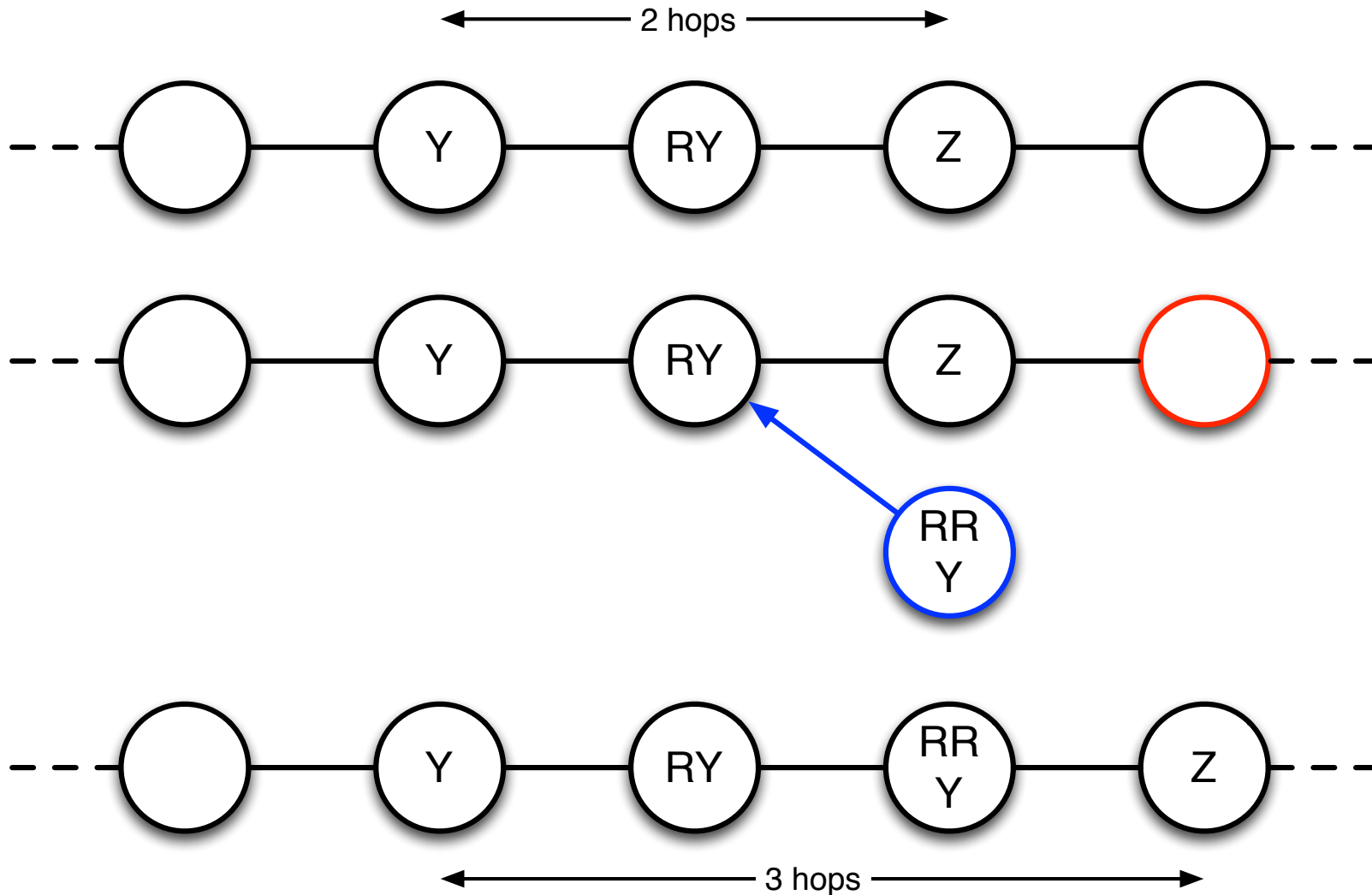



# **Fair vs. Unfair Protocols**

# Fair Local Protocols?

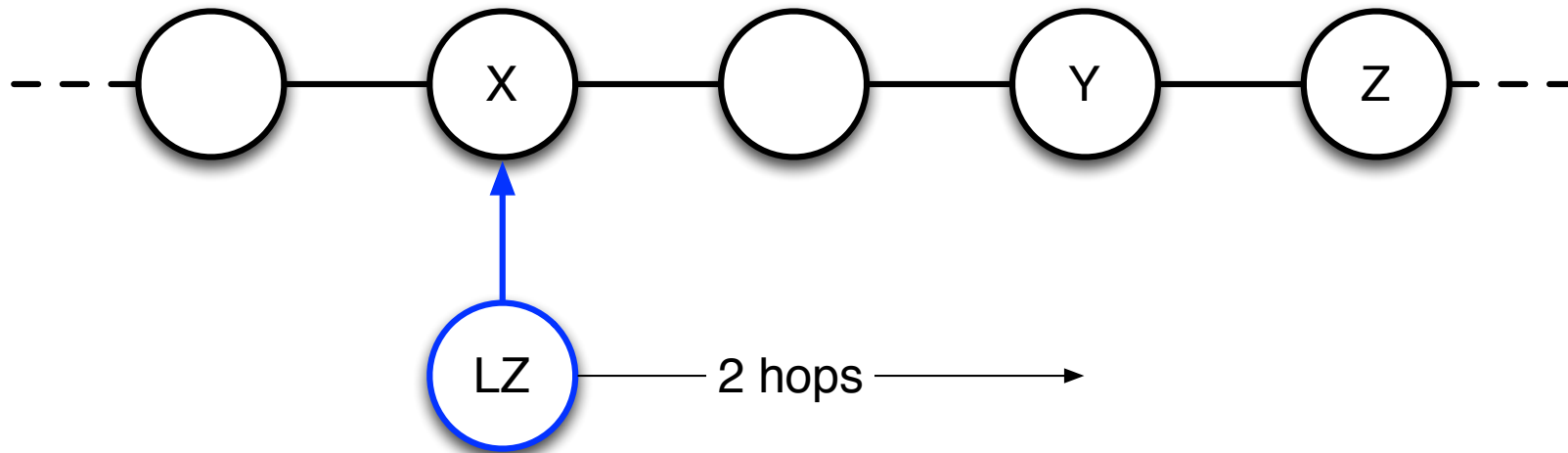

# Fair Local Protocols?

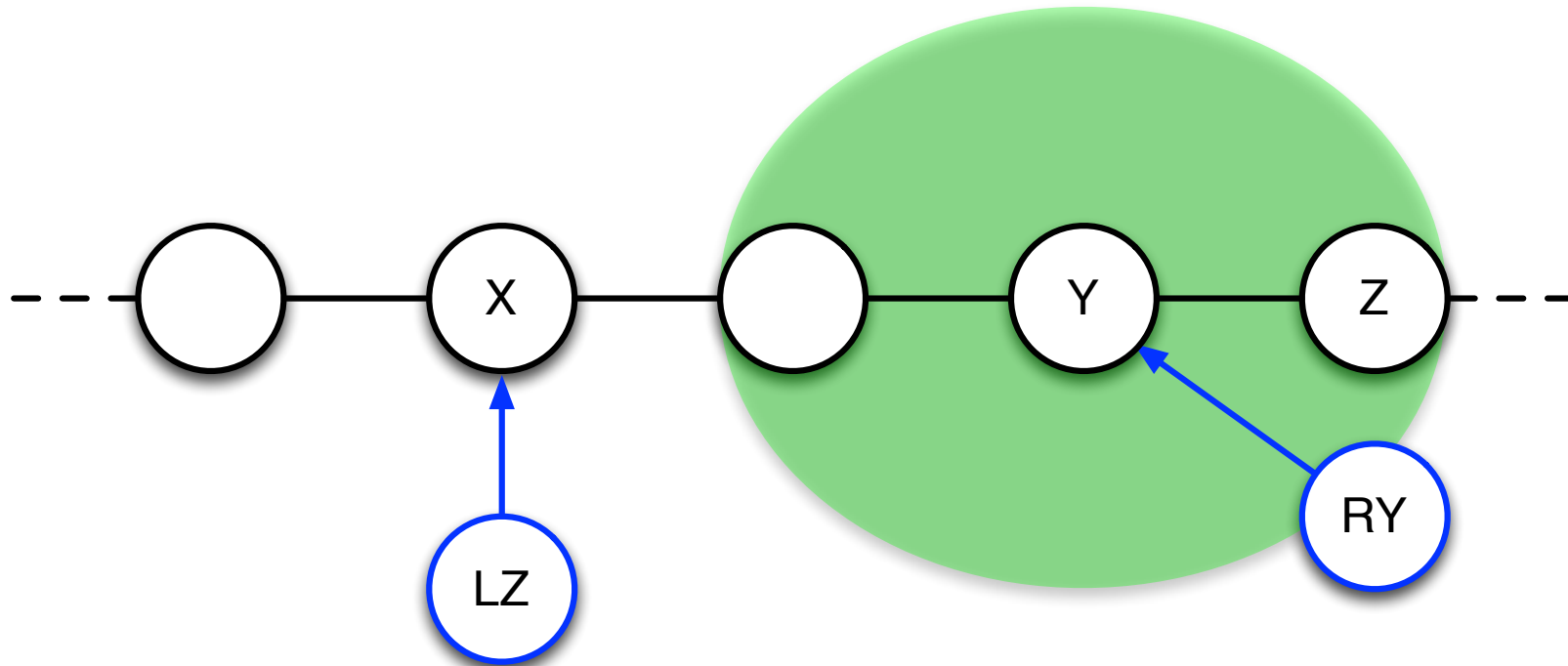

# Fair Local Protocols?

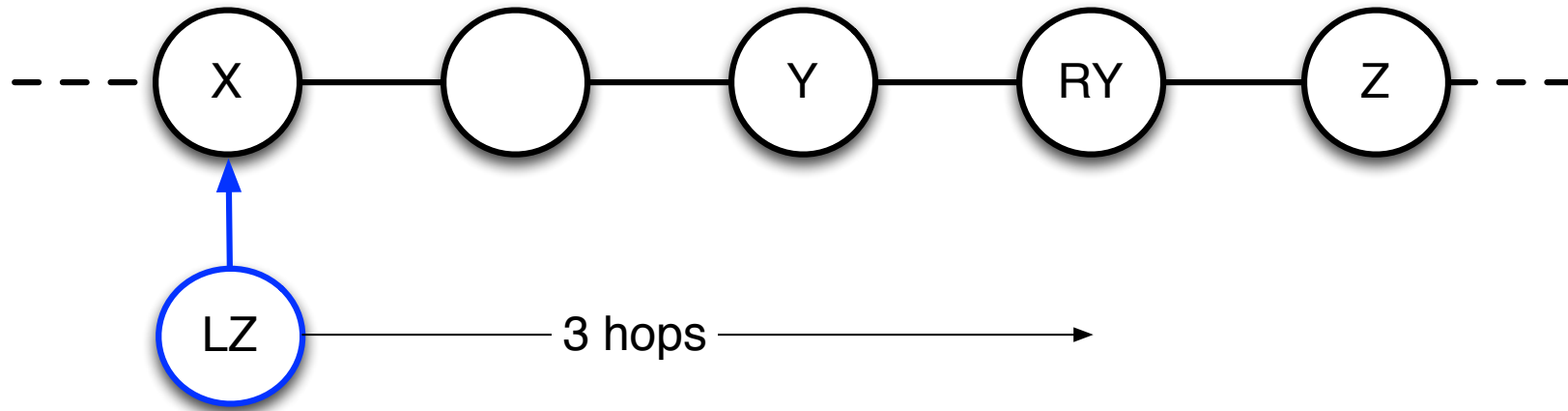

# Fair Local Protocols?

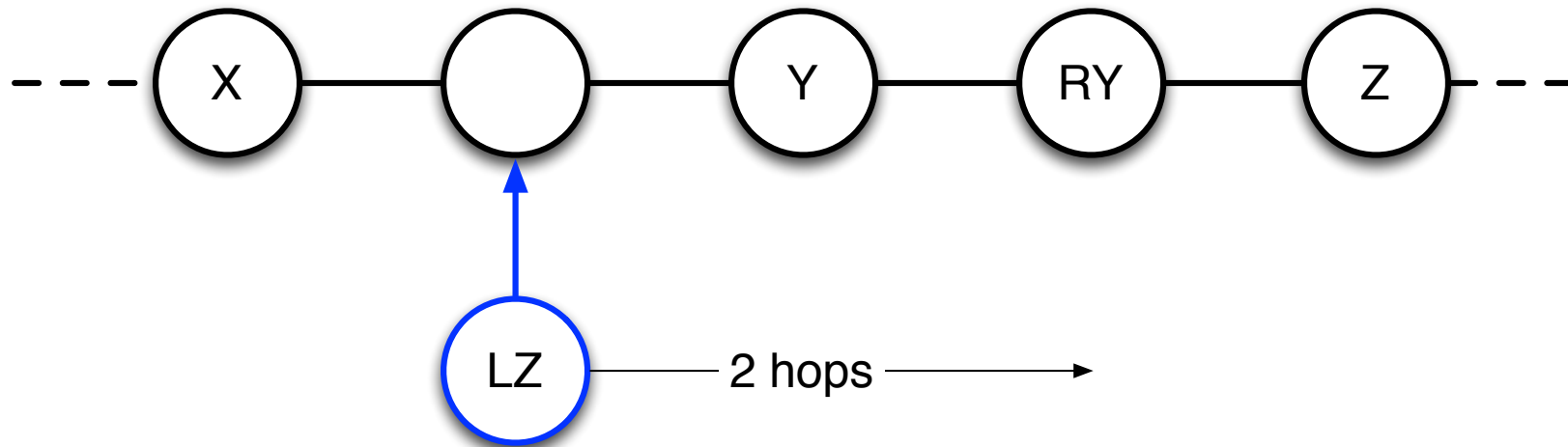

# Fair Local Protocols?

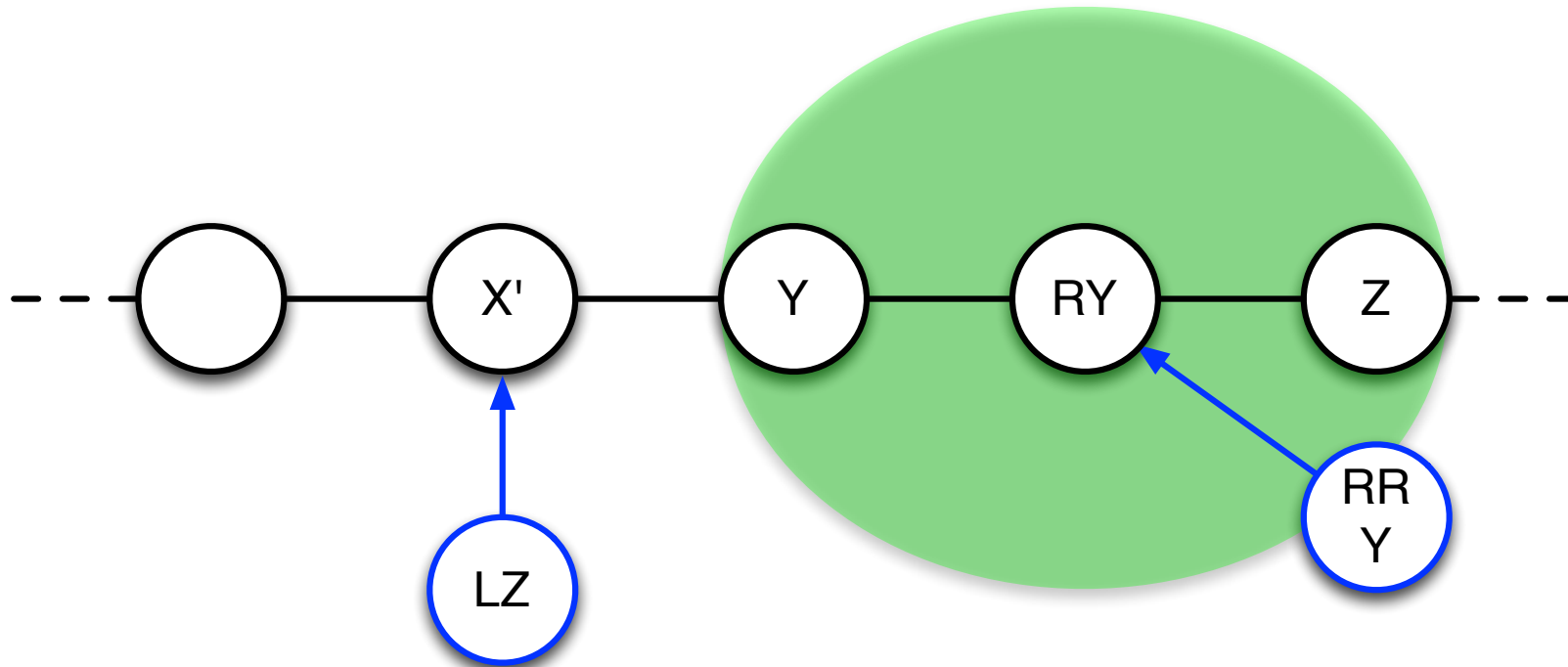

# Fair Local Protocols?

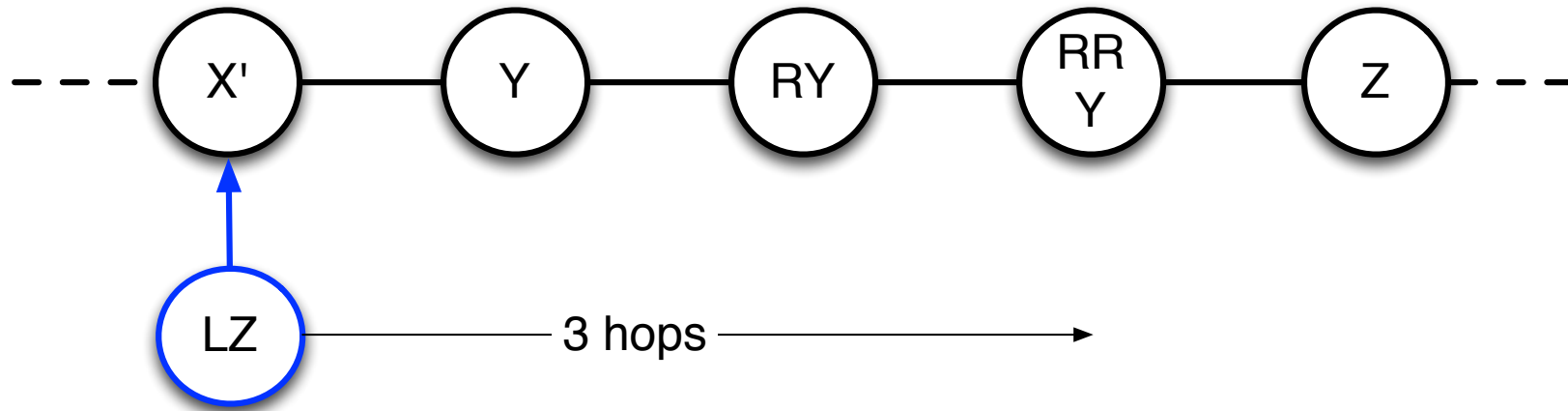

# Fair Local Protocols?

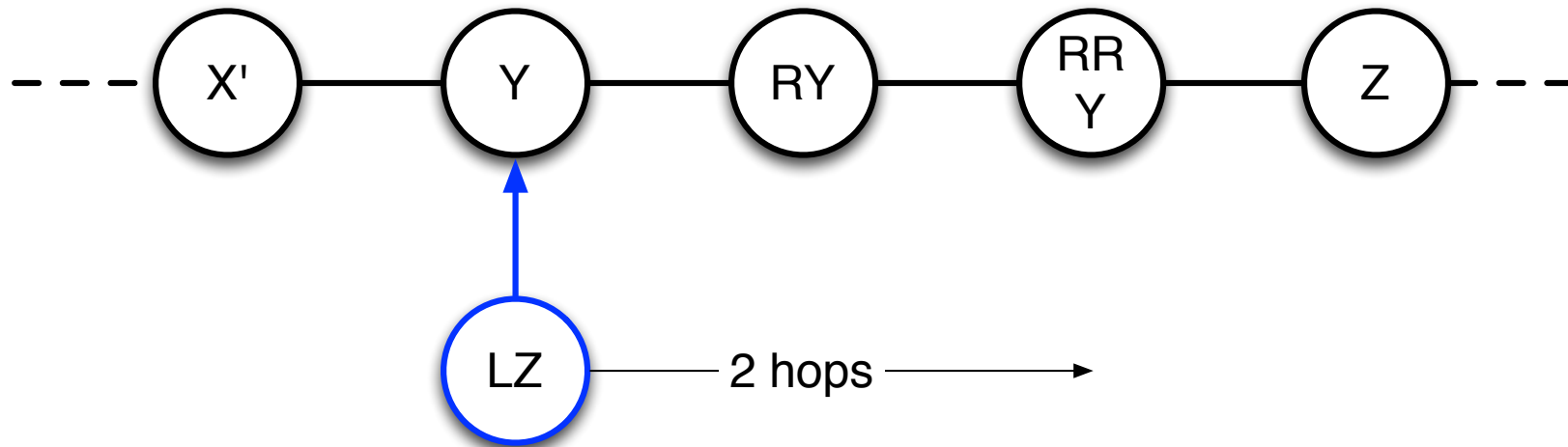



# Fair Local Protocols?

		Finite		Infinite	
		Limited	Unlimited	Limited	Unlimited
Global		Possible			
Local	Fair	?	Impossible	?	
	Unfair	?			

# Fair Local Protocols?

		Finite		Infinite	
		Limited	Unlimited	Limited	Unlimited
Global		Possible			
Local	Fair	?		Impossible	
	Unfair	?			

# Unfair Overlays

# Unfair Infinite Unlimited Linear Overlay

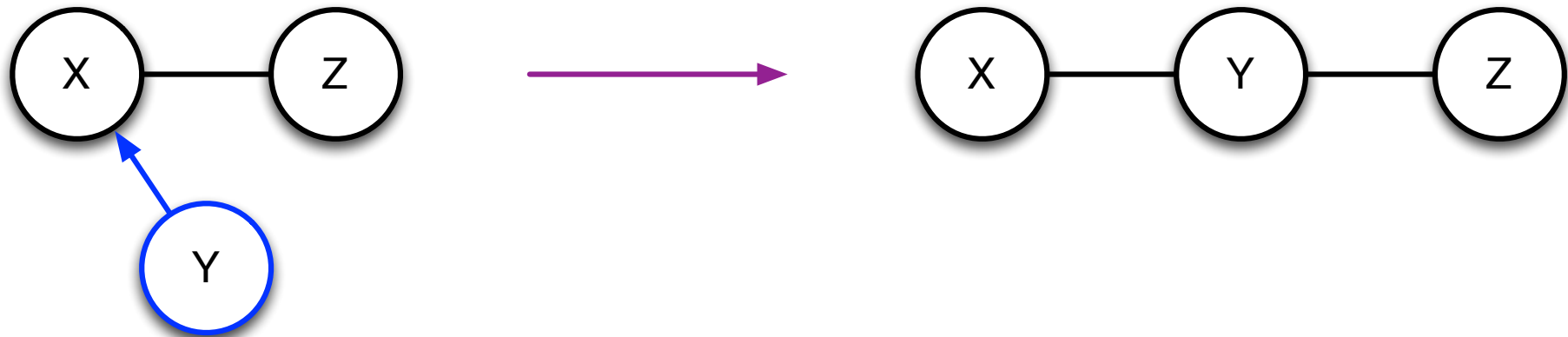

# Unfair Infinite Unlimited Linear Join

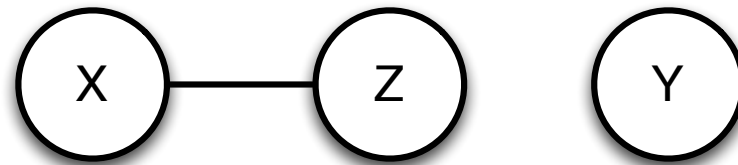

# Unfair Infinite Unlimited Linear Join

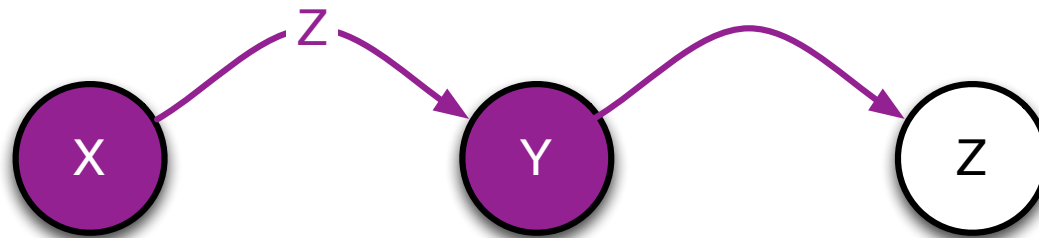
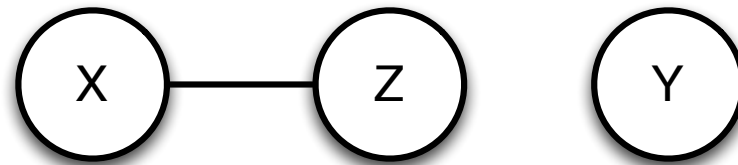

# Unfair Infinite Unlimited Linear Join

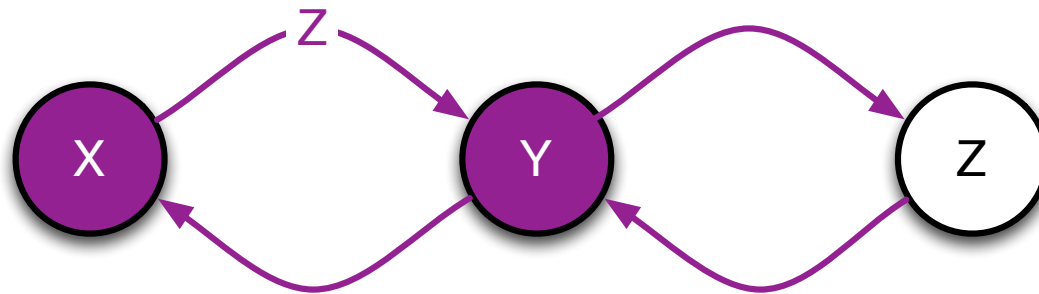
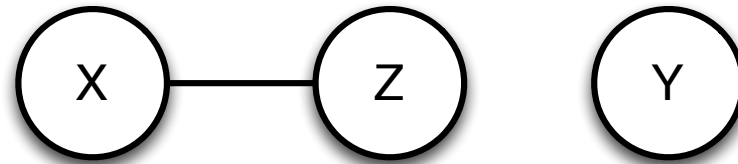

# Unfair Infinite Unlimited Linear Join

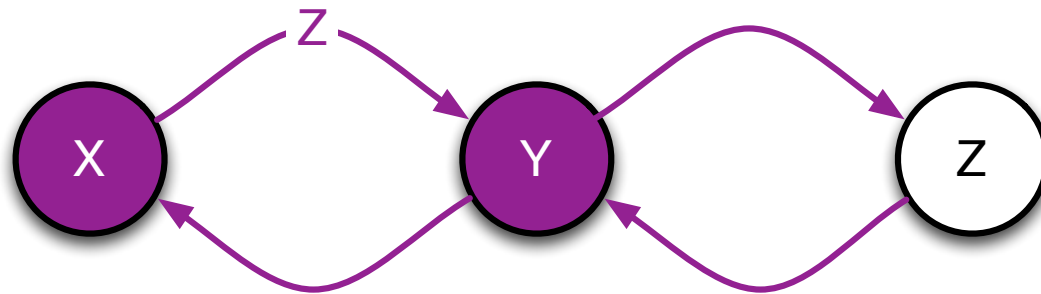
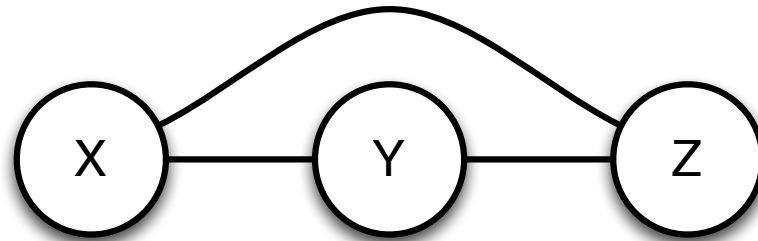



# Unfair Infinite Unlimited Linear Join

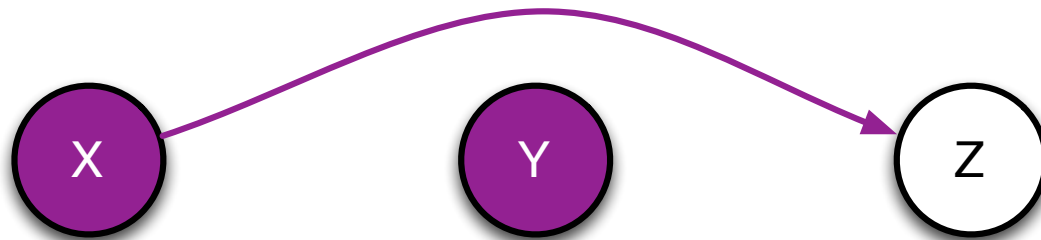
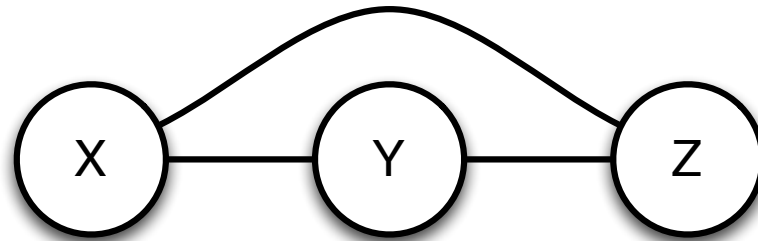

# Unfair Infinite Unlimited Linear Join

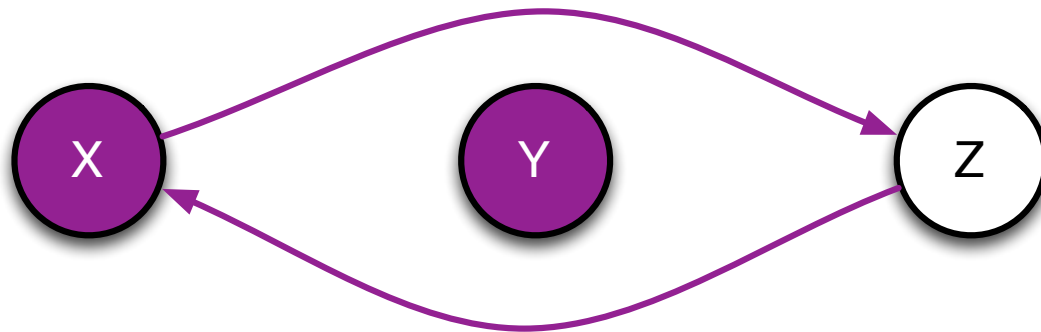
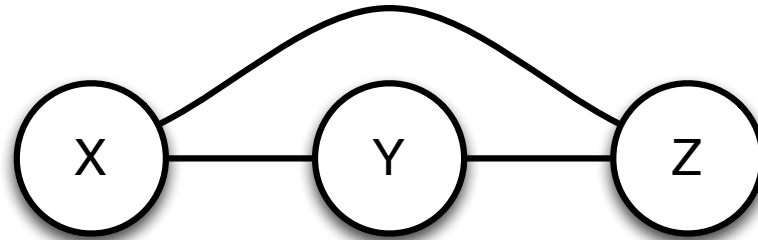

# Unfair Infinite Unlimited Linear Join

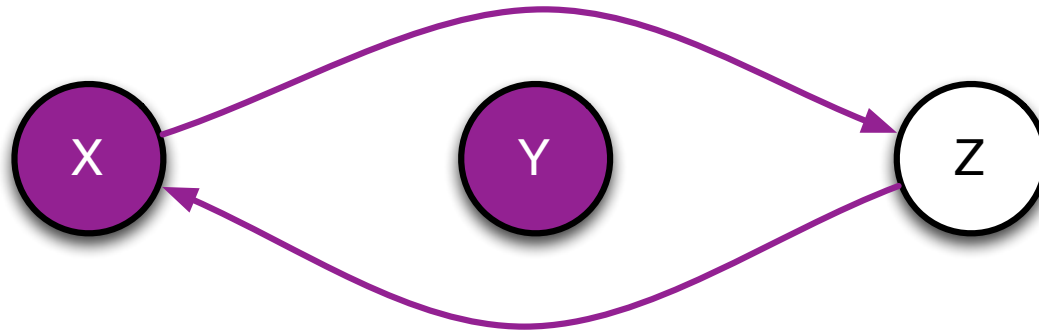
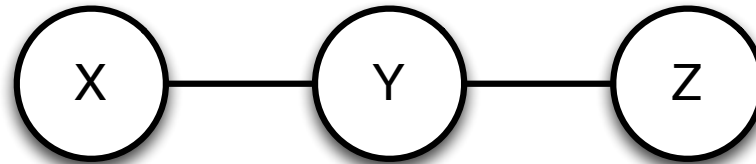

# Unfair Infinite Unlimited Linear Join

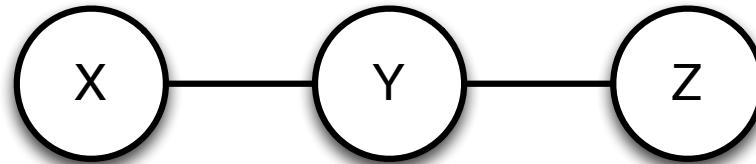

# Unfair Infinite Unlimited Linear Join

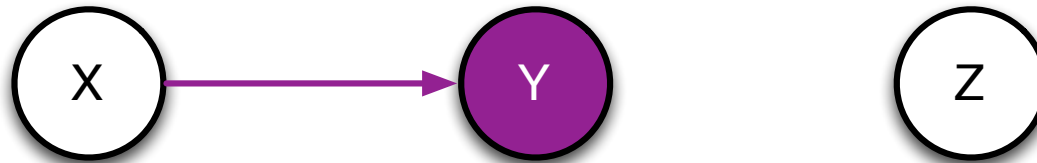
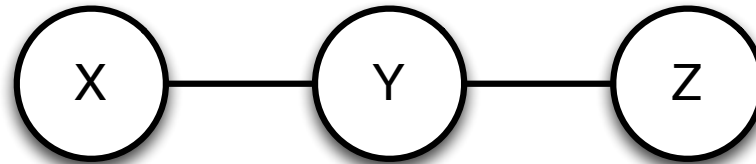

# Unfair Infinite Unlimited Linear Join

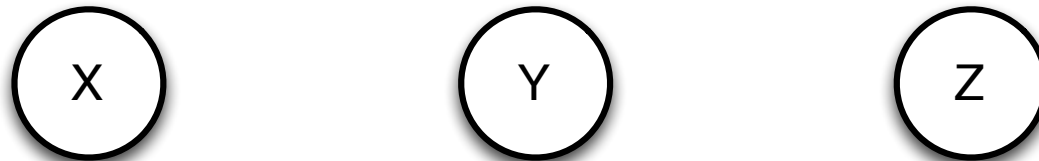
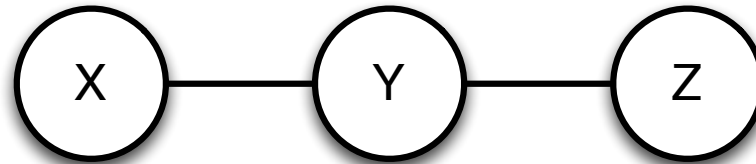

# Unfair Infinite Unlimited 1-2 Skip List Overlay

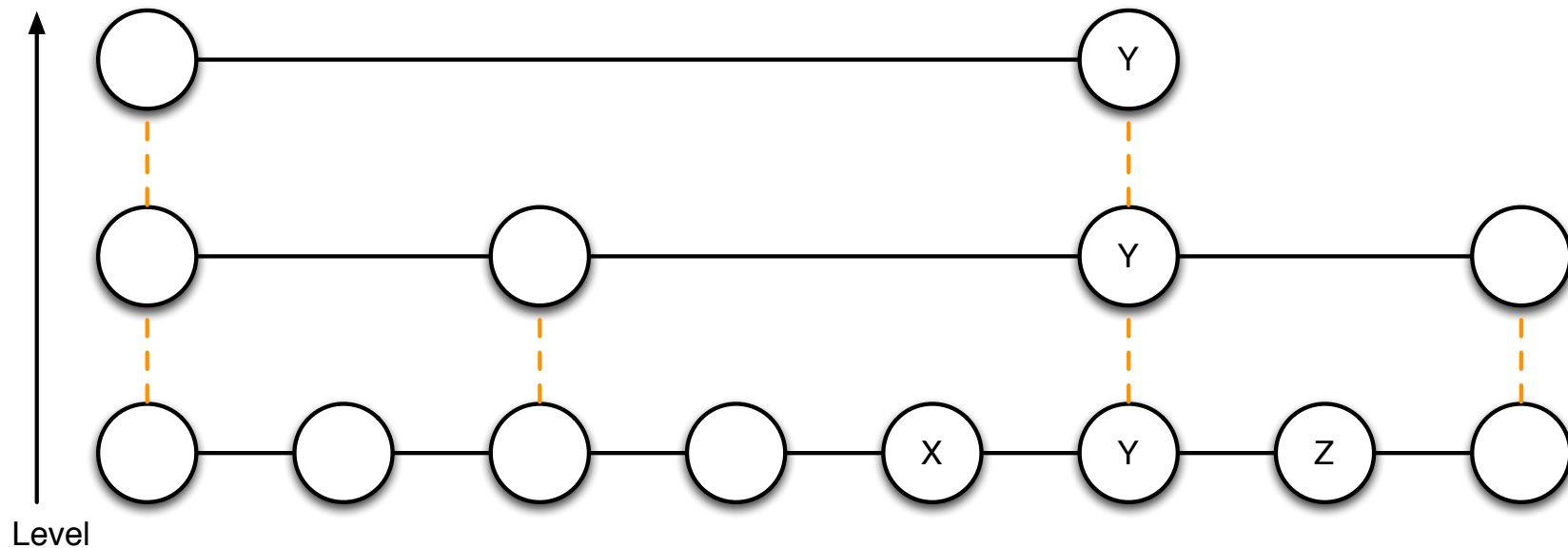

# Unfair Infinite Unlimited 1-2 Skip List Overlay

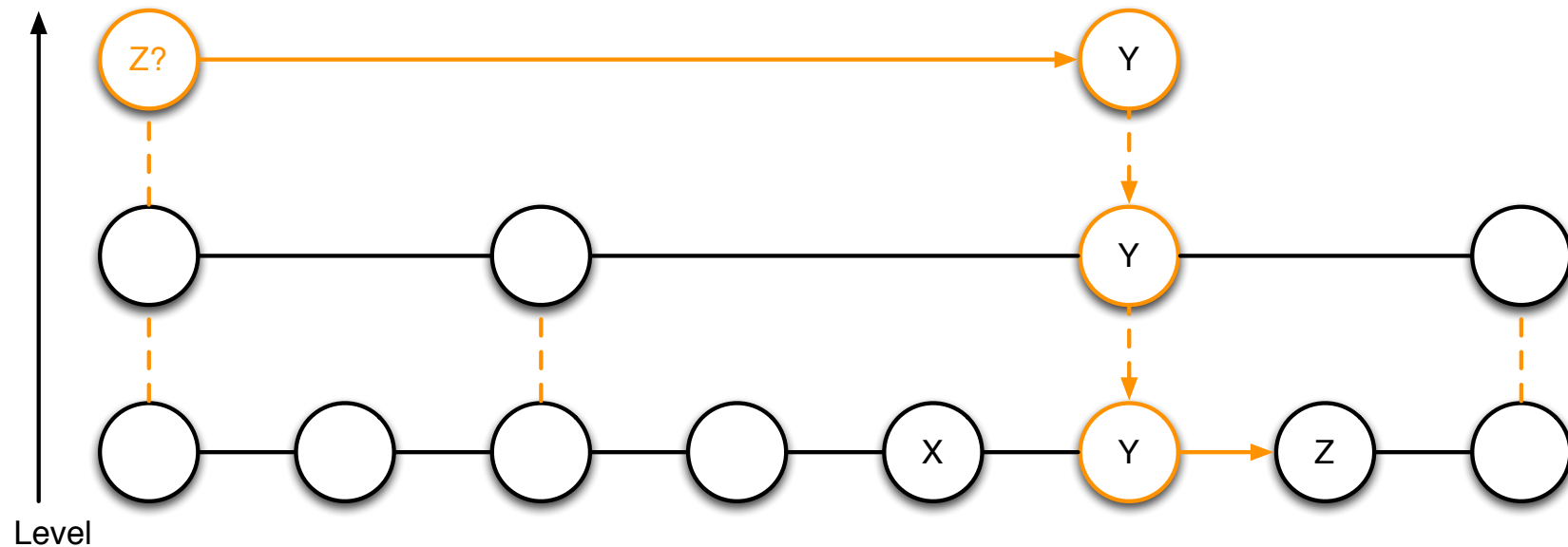



# Unfair Infinite Unlimited

## 1-2 Skip List Join

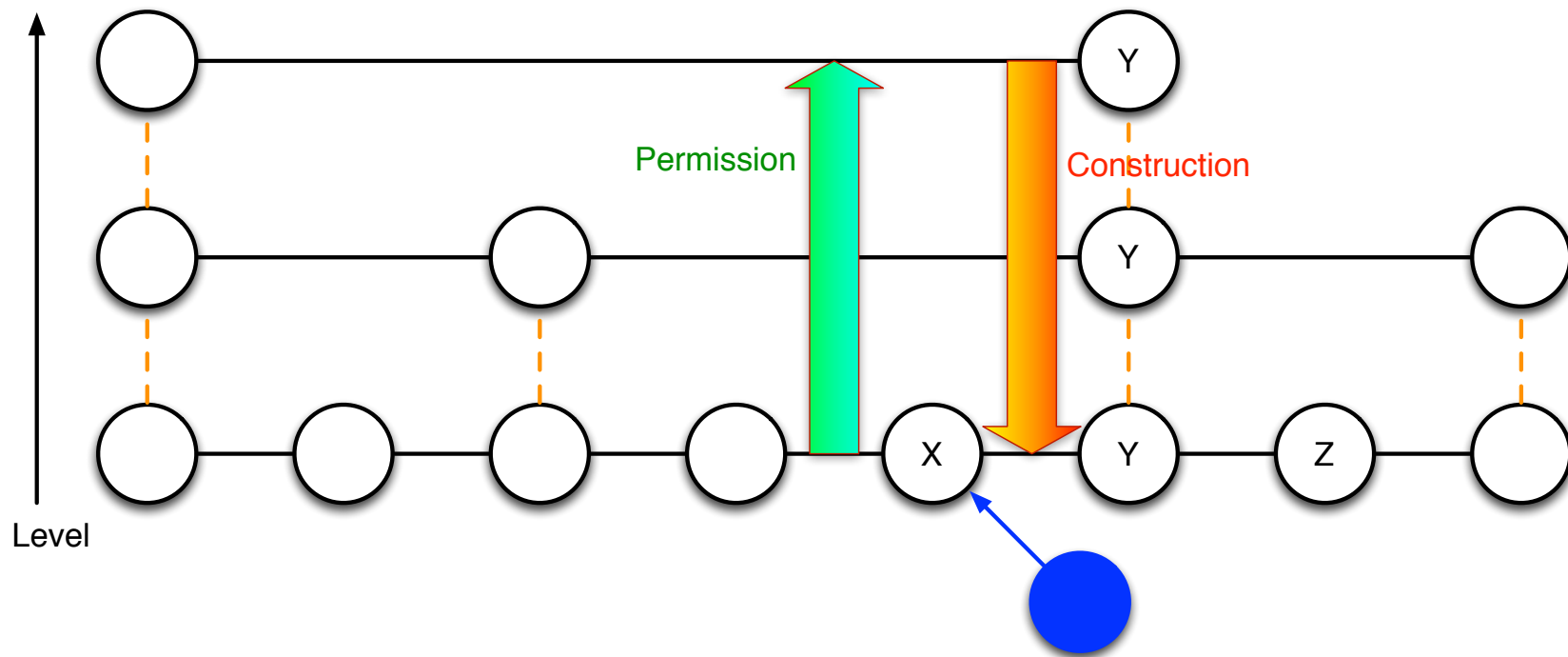

# Unfair Infinite Unlimited

## 1-2 Skip List Join (1/5)

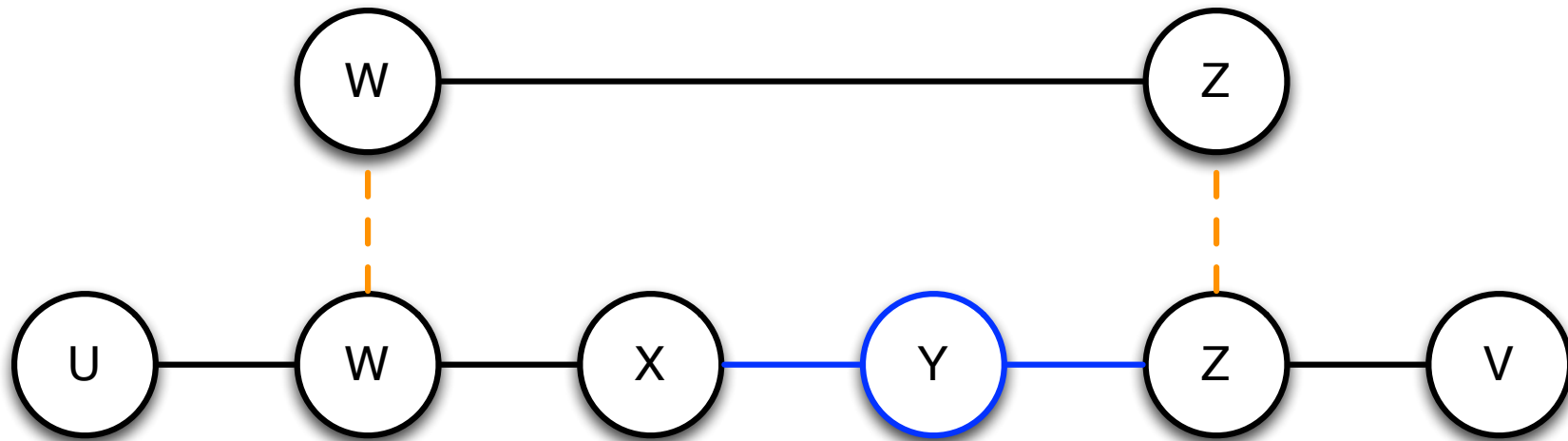

# Unfair Infinite Unlimited

## 1-2 Skip List Join (1/5)

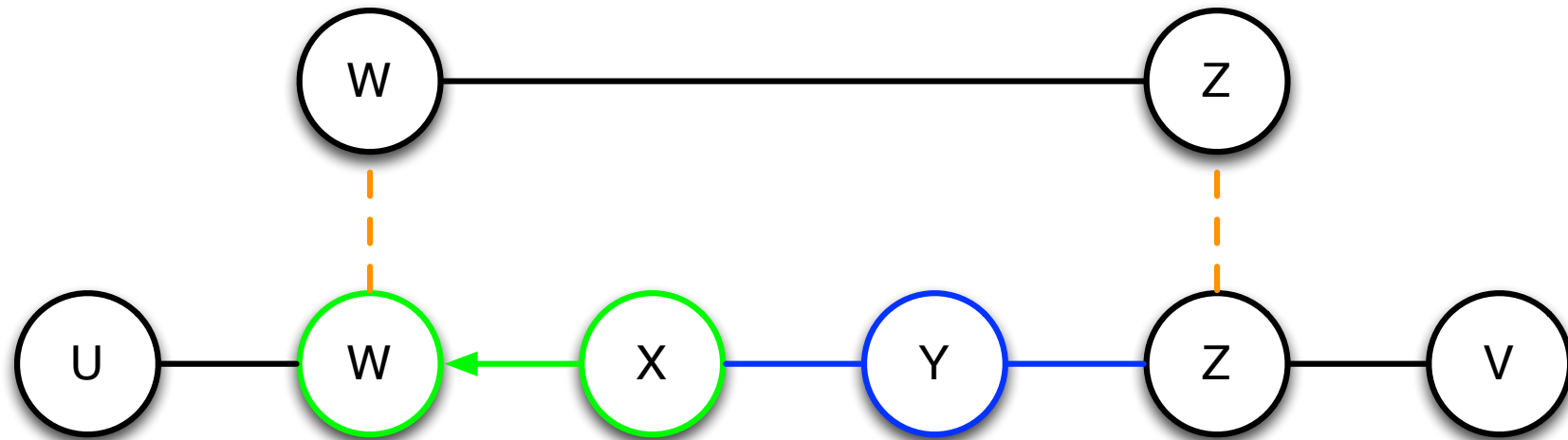

# Unfair Infinite Unlimited

## 1-2 Skip List Join (2/5)

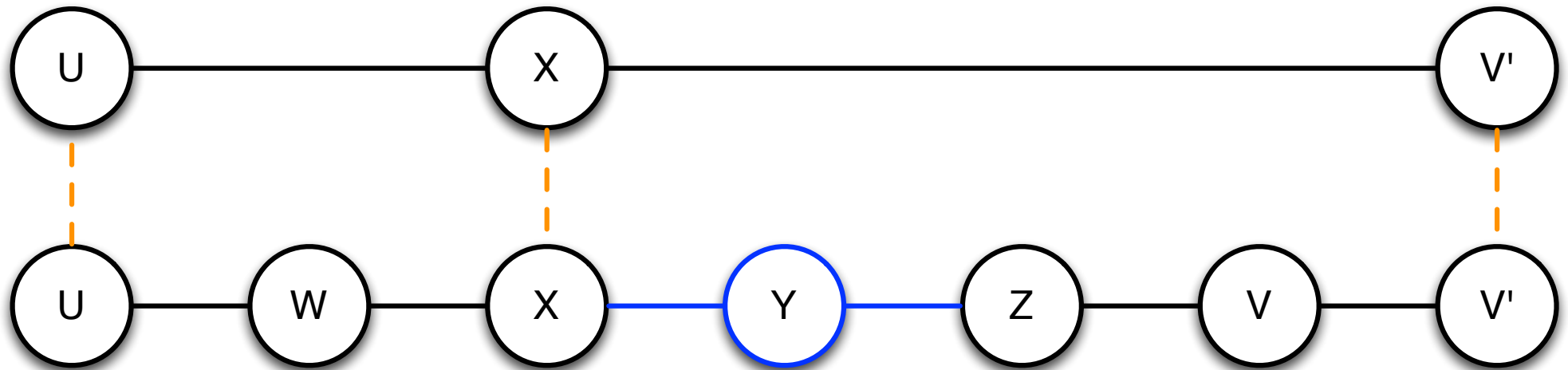

# Unfair Infinite Unlimited

## 1-2 Skip List Join (2/5)

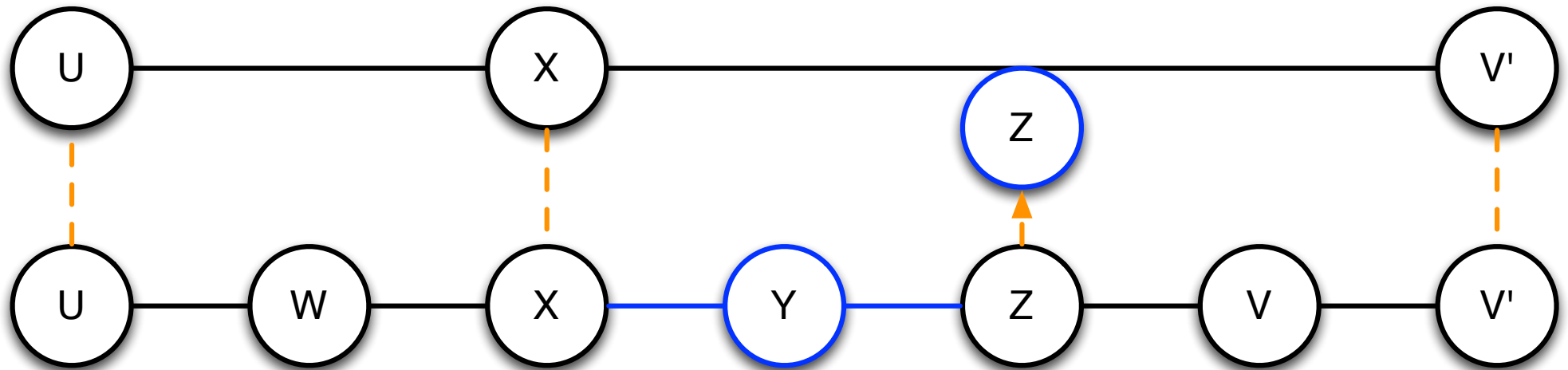

# Unfair Infinite Unlimited

## 1-2 Skip List Join (2/5)

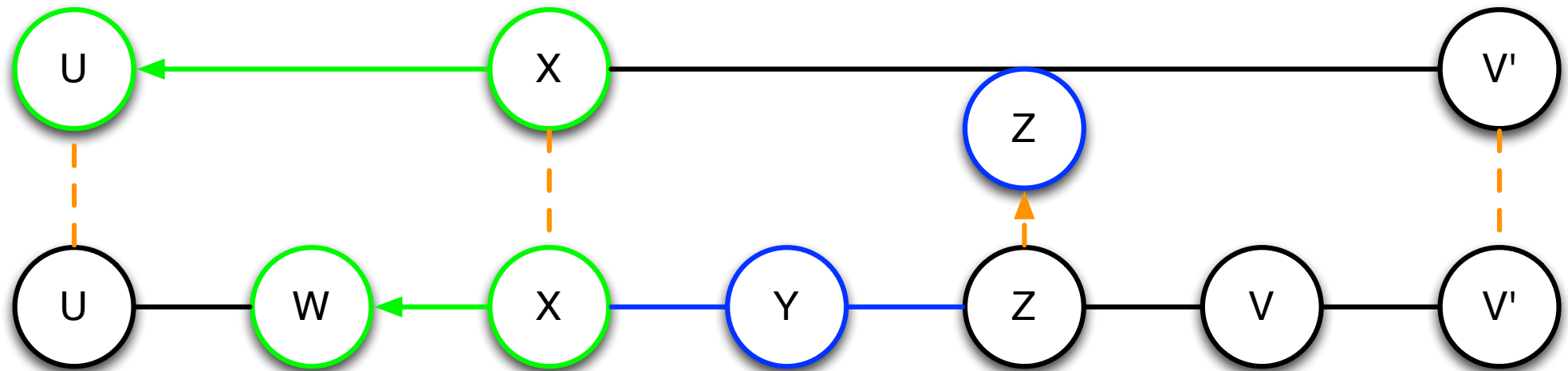

# Unfair Infinite Unlimited

## 1-2 Skip List Join

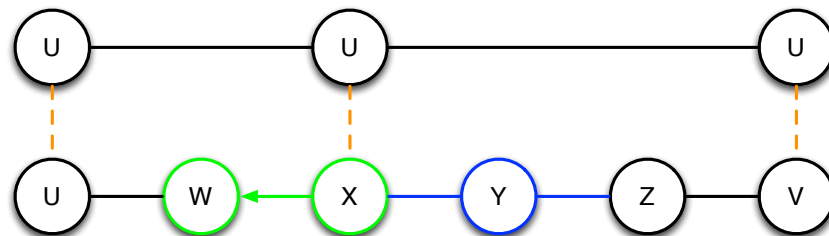
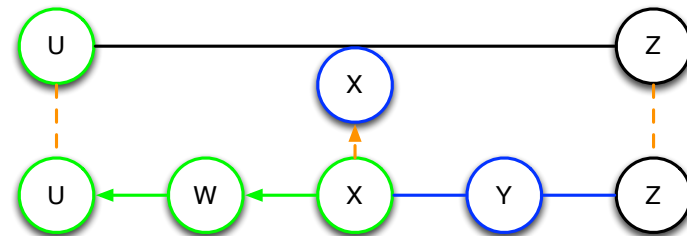
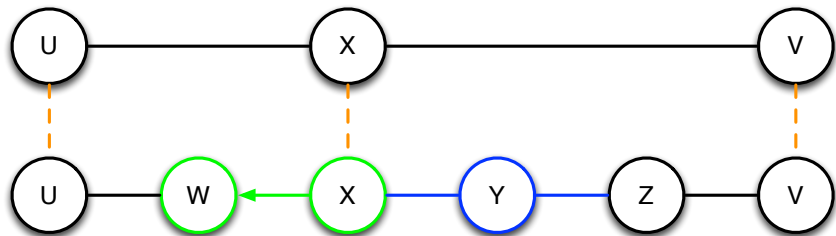
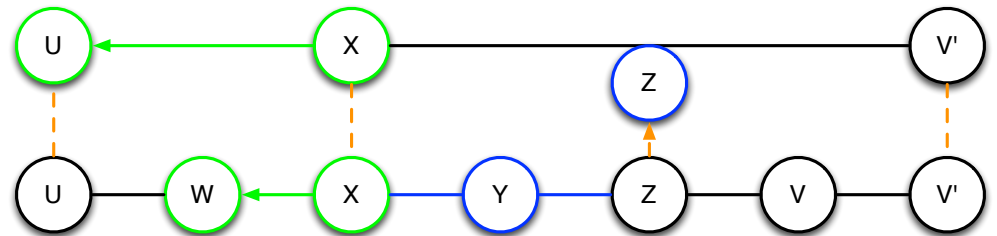
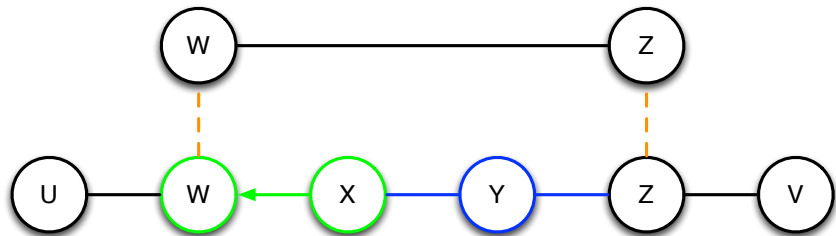

# Unfair Infinite Unlimited

## 1-2 Skip List Leaf

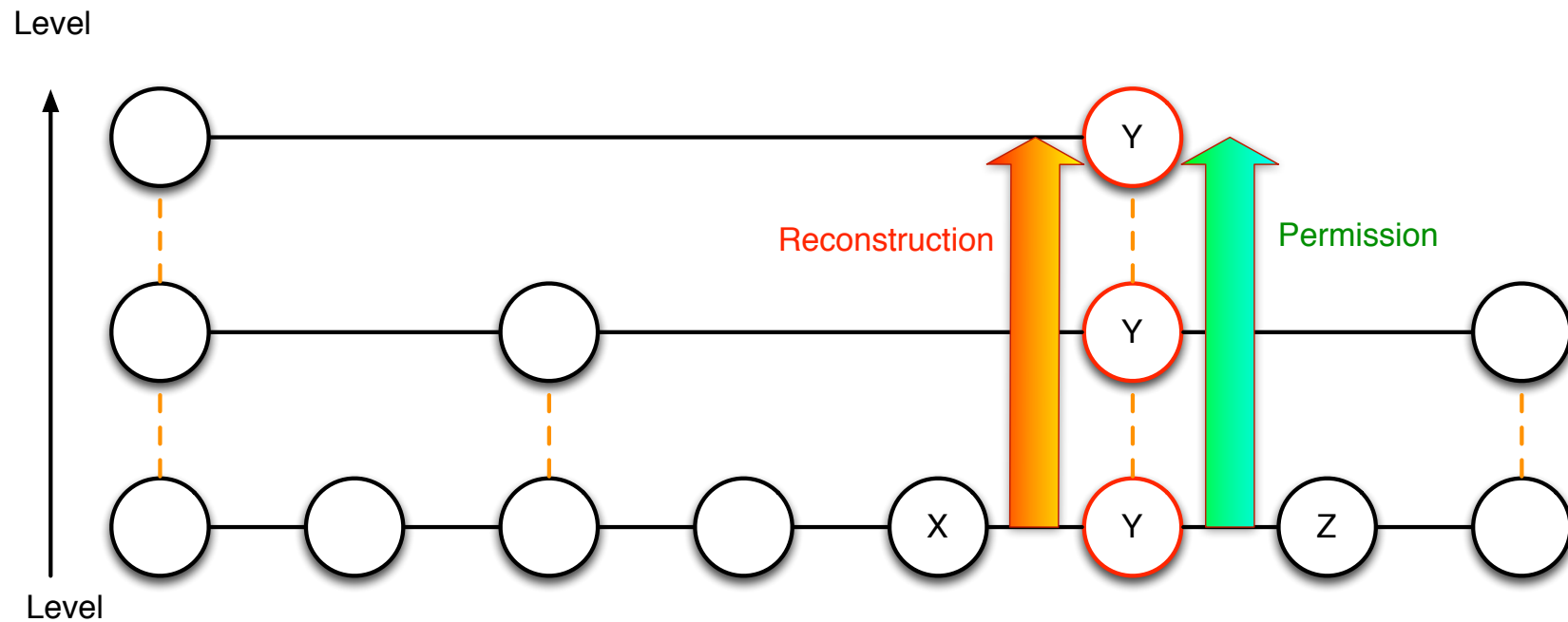



# Unfair Infinite Unlimited

## 1-2 Skip List Leave

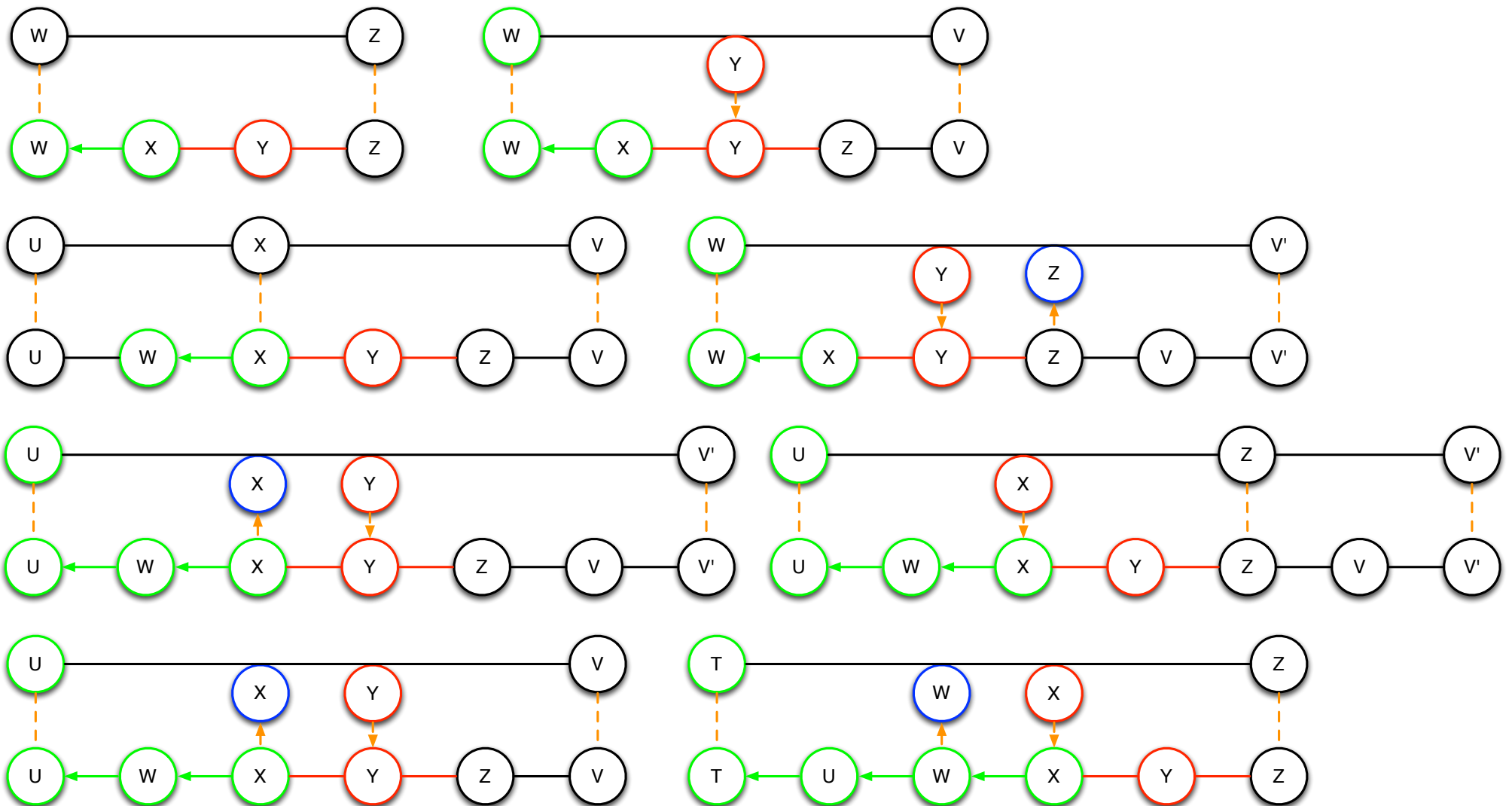

# Unfair Infinite Unlimited

## 1-2 Skip List

		Finite		Infinite	
		Limited	Unlimited	Limited	Unlimited
Global		Possible			
Local	Fair	?		Impossible	
	Unfair	?			Possible

# Unfair Infinite Unlimited

## 1-2 Skip List

		Finite		Infinite	
		Limited	Unlimited	Limited	Unlimited
Global		Possible			
Local	Fair	?		Impossible	
	Unfair	?		Possible	

# Unfair Infinite Unlimited

## 1-2 Skip List

		Finite		Infinite	
		Limited	Unlimited	Limited	Unlimited
Global		Possible			
Local	Fair	?		Impossible	
	Unfair	Possible			

# Unfair Infinite Unlimited

## 1-2 Skip List

		Finite		Infinite	
		Limited	Unlimited	Limited	Unlimited
Global		Possible			
Local	Fair	Possible		Impossible	
	Unfair	Possible			

**Conclusion**

# Churn Possibilities and Impossibilities

		Finite		Infinite	
		Limited	Unlimited	Limited	Unlimited
Global		Possible			
Local	Fair	Possible		Impossible	
	Unfair	Possible			

# Open Questions

- **Other topologies:**
  - 2-3 skip list,
  - Chord, ...
- **Practical impact of unfairness**



**Thank You**